

**— = systeemkabel**  
 Bij andere getwiste kabel 66% afstand!  
 Bij ongetwiste kabel max. 50 meter buitenpost naar videofoon.  
 UTP op aanvraag.

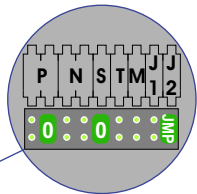

DEURSTATION S-140V

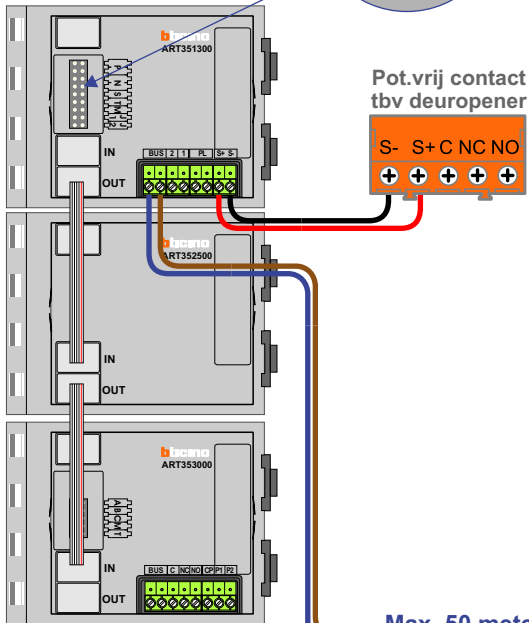

Max. 50 meter



Haal de spanning van het systeem als je een digitizer monteert of demonteert

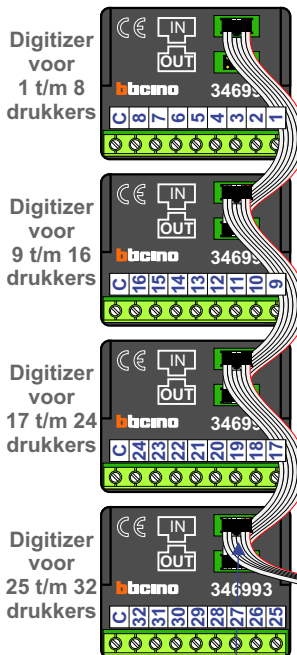

nokjes connectoren wijzen naar elkaar

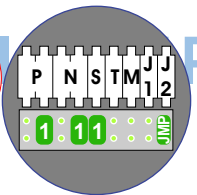

DEURSTATION S-130V

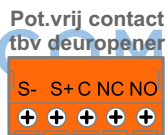

Max. 50 meter

Max. 100 meter systeemkabel tot laatste videofoon

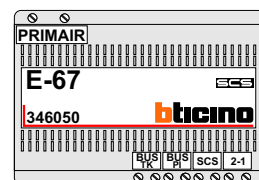

naar VV pagina 2

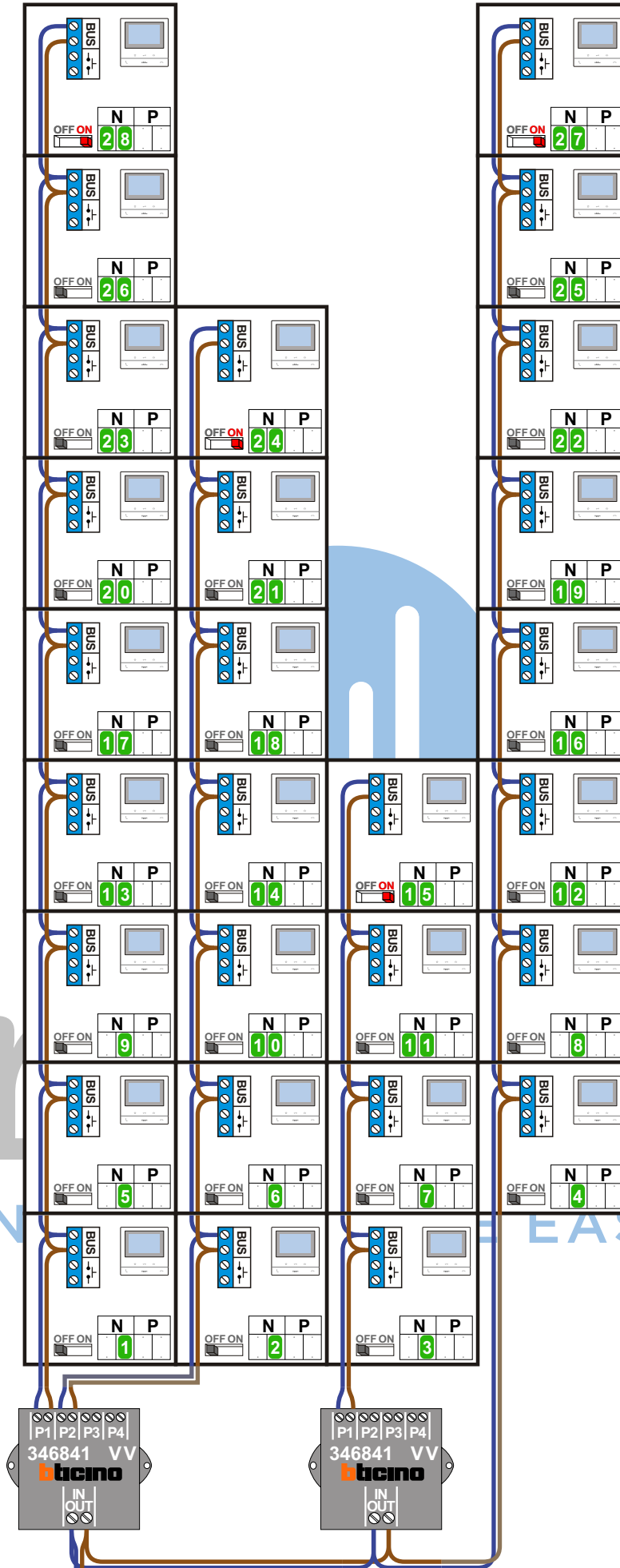

M-50b

**BUS**

De aders moeten echt OP de connector doorgelust worden!

---

VideoVerdeler

De aders moeten echt OP de klemmen doorgelust worden!

N-waarde	Huisnummer	Eindweerstand
1	9B	
2	9A	
3	9	
4	11C	
5	11B	
6	11A	
7	11	
8	13C	
9	13B	
10	13A	
11	13	
12	15C	
13	15B	
14	15A	
15	15	x
16	17B	
17	17A	
18	17	
19	19B	
20	19A	
21	19	
22	21B	
23	21A	
24	21	x
25	23A	
26	23	
27	23C	x
28	23B	x

nelec  
INTERCOM MADE EASY