

— = systeemkabel
Bij andere getwiste kabel 66% afstand!
Bij ongetwiste kabel max. 50 meter buitenpost naar videofoon.
UTP op aanvraag.

M-43 M-70 M-70W
BUS
De aders moeten echt OP de connector doorgelust worden!

VideoVerdeler
De aders moeten echt OP de klemmen doorgelust worden!

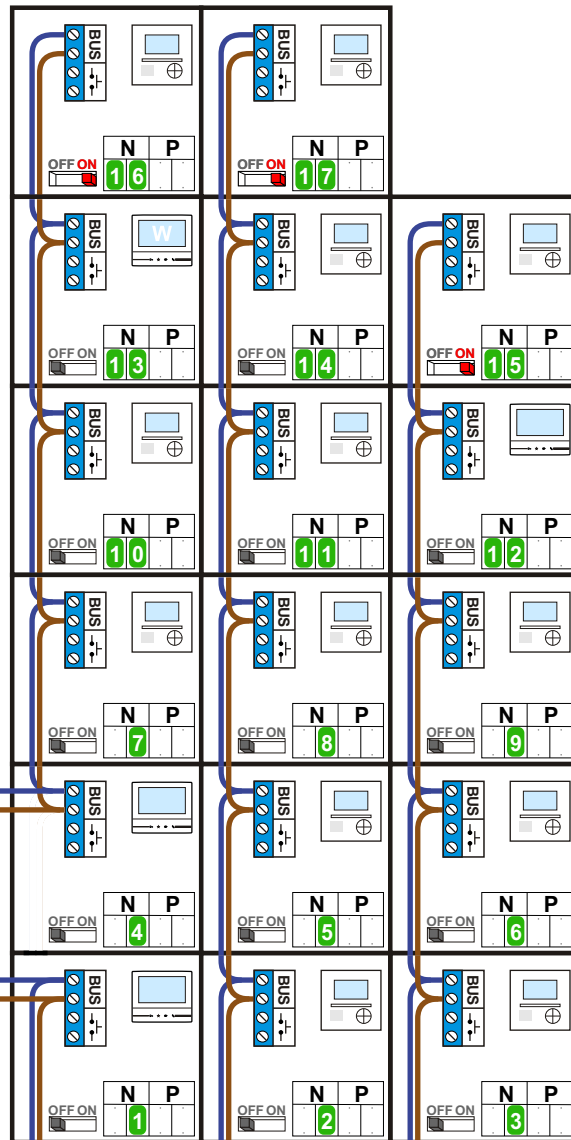
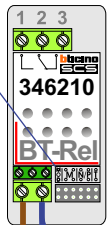
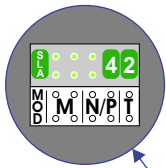

nelec
INTERCOM MADE EASY

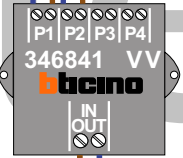
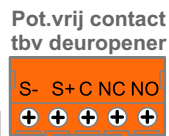
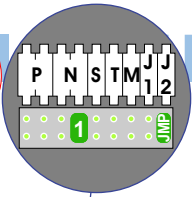
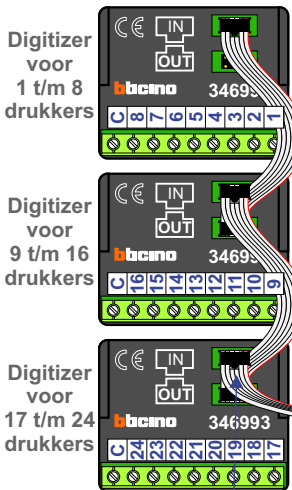

Max. 100 meter systeemkabel tot laatste videofoon

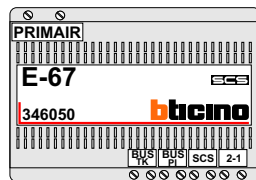

nokjes connectoren wijzen naar elkaar

Max. 50 meter

N-waarde	Huisnummer	Switch ON	Videfoon
1	41		M70
2	43		M-43
3	45		M-43
4	47		M-70
5	49		M-43
6	51		M-43
7	53		M-43
8	55		M-43
9	57		M-43
10	59		M-43
11	61		M-43
12	63		M-70
13	65		M-70W
14	67		M-43
15	69	X	M-43
16	71	X	M-43
17	73	X	M-43



nelec
INTERCOM MADE EASY