

— = systeemkabel
Bij andere getwiste kabel 66% afstand!
Bij ongetwiste kabel max. 50 meter buitenpost naar videofoon. UTP op aanvraag.

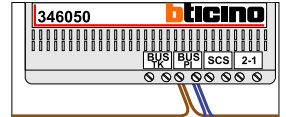

De twee stijgers echt OP de klemmen van E-67 aansluiten!

M-43

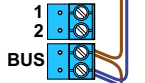

De aders moeten echt OP de connector doorgelust worden!

VideoVerdeler



De aders moeten echt OP de klemmen doorgelust worden!

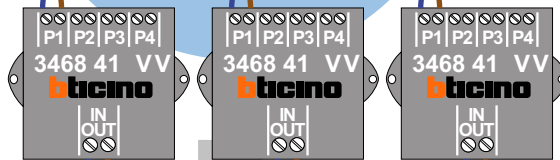
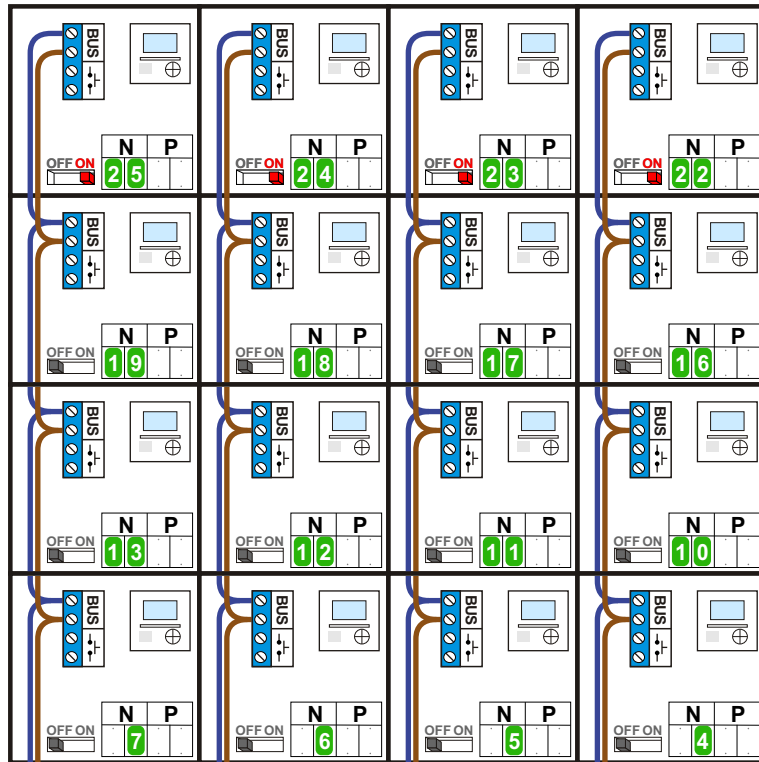

Naar VV pagina 2

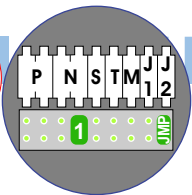
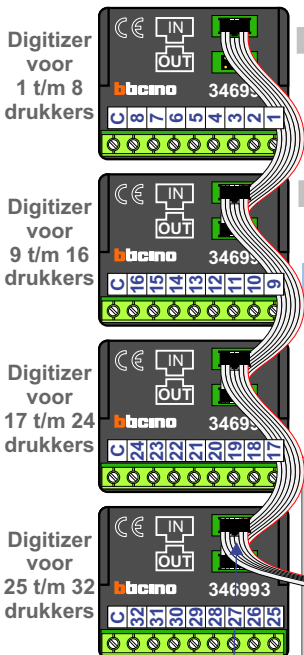

12 Vdc opener

DEURSTATION S-130V

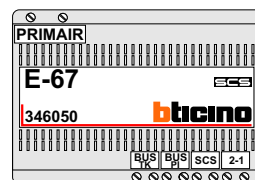
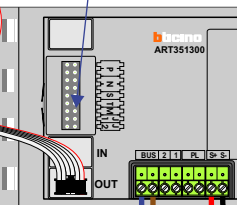

Max. 100 meter systeemkabel tot laatste videofoon

nokjes connectoren wijzen naar elkaar

Max. 50 meter

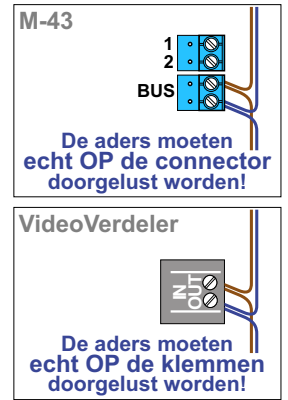
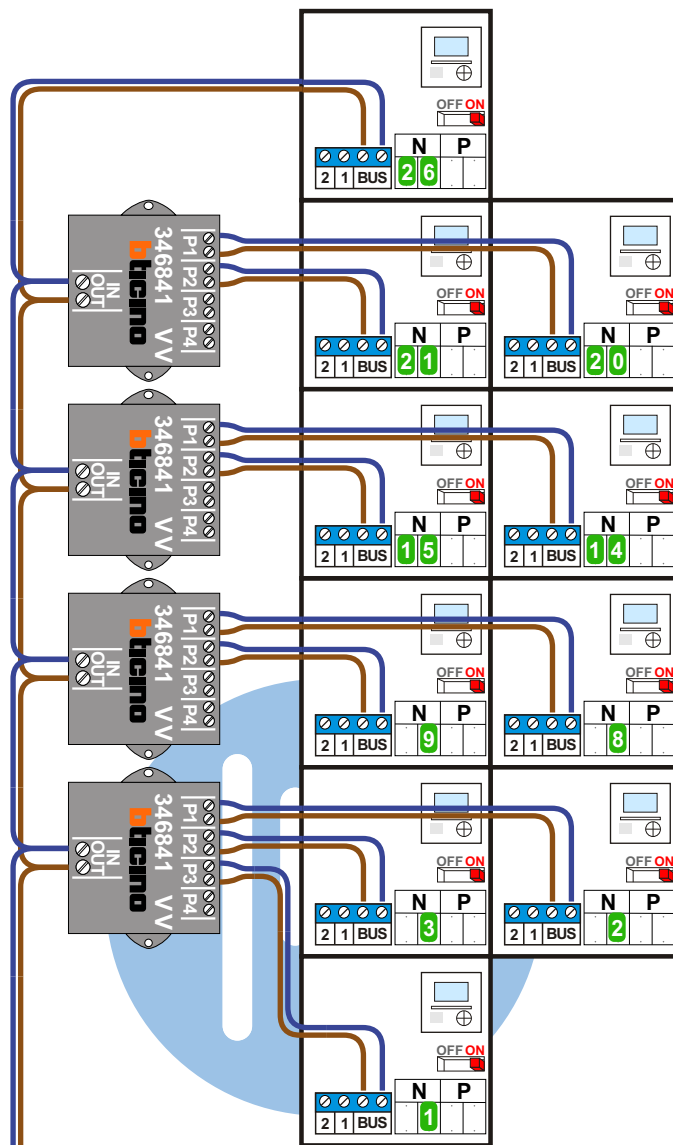

Van E-67 pagina 1

nelec
INTERCOM MADE EASY

N-waarde	Huisnummer	Switch ON
1	9	X
2	11	X
3	13	X
4	15	
5	17	
6	19	
7	21	
8	23	X
9	25	X
10	27	
11	29	
12	31	
13	33	
14	35	X
15	37	X
16	39	
17	41	
18	43	
19	45	
20	47	X
21	49	X
22	51	X
23	53	X
24	55	X
25	57	X
26	59	X



nelec
INTERCOM MADE EASY