

— = systeemkabel
 Bij kabel 2 x 1 mm²:
 180% afstand!
 Bij kabel 2 x 0,28 mm²:
 60% afstand!
 UTP op aanvraag.

Bij installaties zonder beeld maakt het niet uit hoe je de bus aansluit. De telefoons hoeven niet in serie en eindweerstand zijn niet nodig.

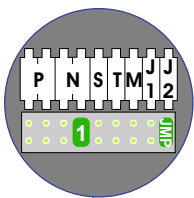

DEURSTATION S-151V

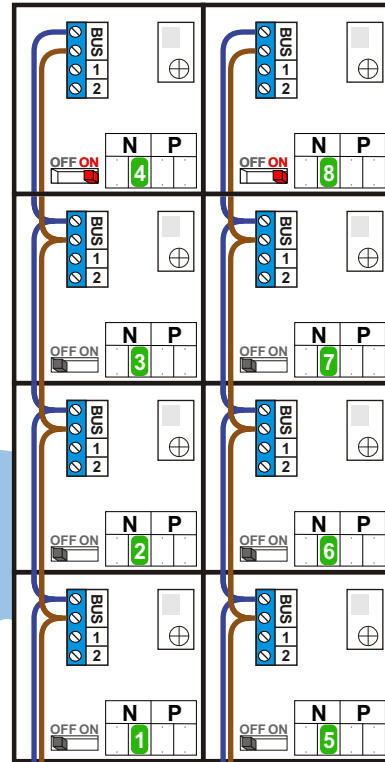
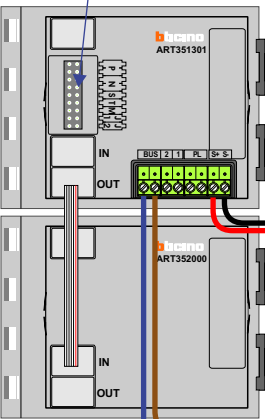

nelec
INTERCOM MADE EASY

Deur 1

Deur 2

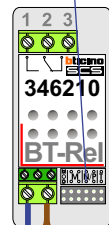
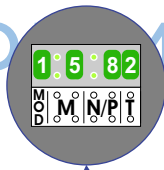
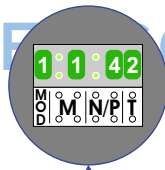

Max. 320 meter systeemkabel tot laatste deurtelefoon

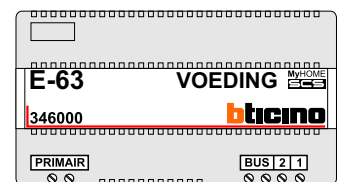

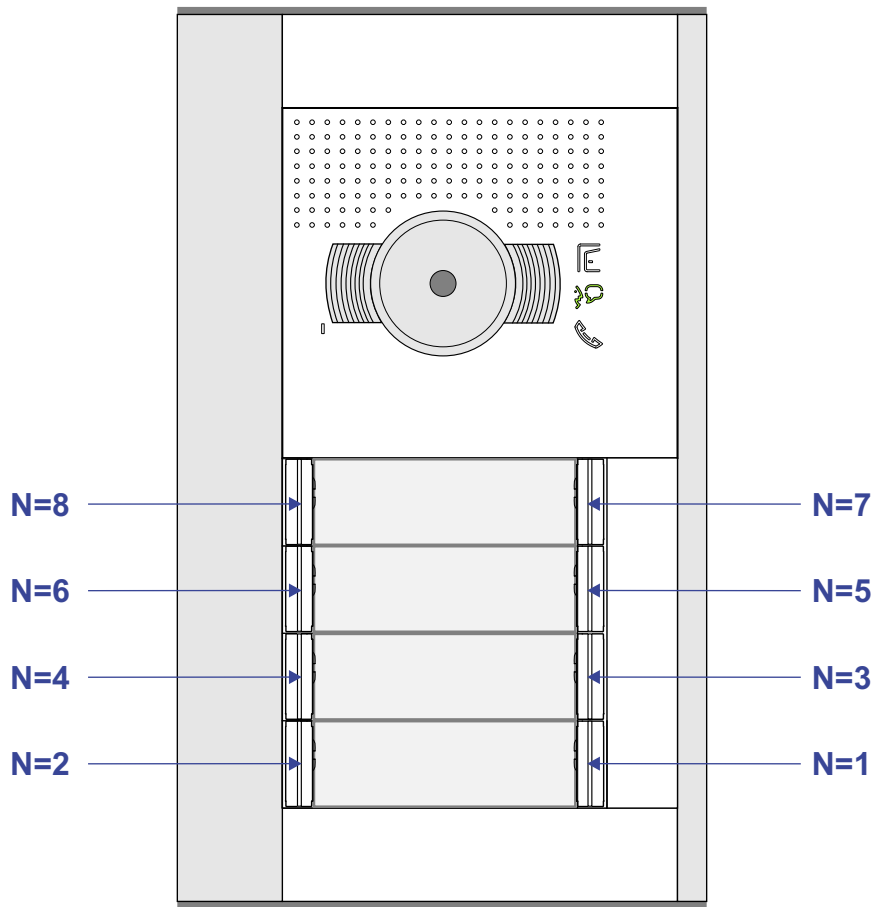

nelec
INTERCOM MADE EASY