

— = systeemkabel
Bij andere getwiste kabel 66% afstand!
Bij ongetwiste kabel max. 50 meter buitenpost naar videofoon.
UTP op aanvraag.

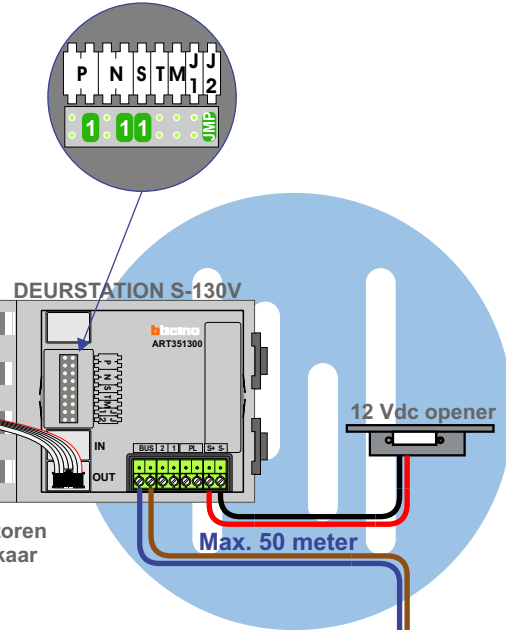

nokjes connectoren wijzen naar elkaar

Max. 50 meter

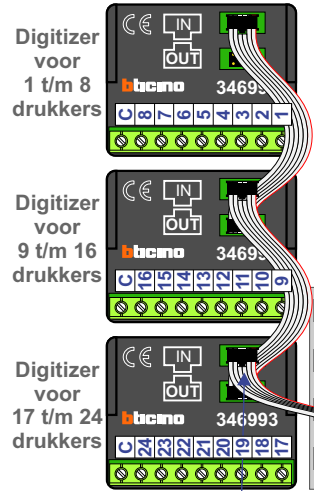
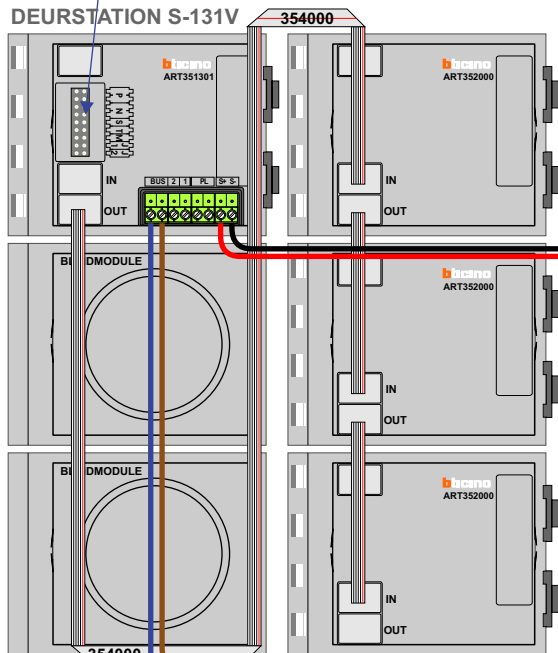
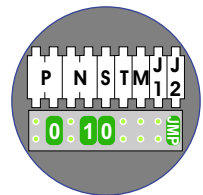
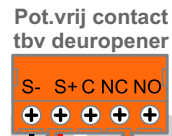

Naar pagina VV pagina 2
Naar pagina VV pagina 2

Max. 100 meter systeemkabel tot laatste videofoon

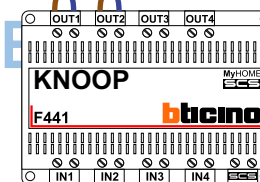

Max. 50 meter

Max. 2 meter

VideoVerdeler



De aders moeten echt OP de klemmen doorgelust worden!

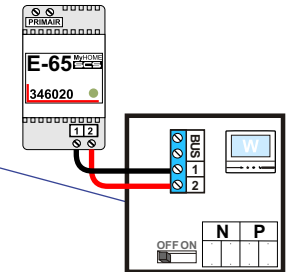
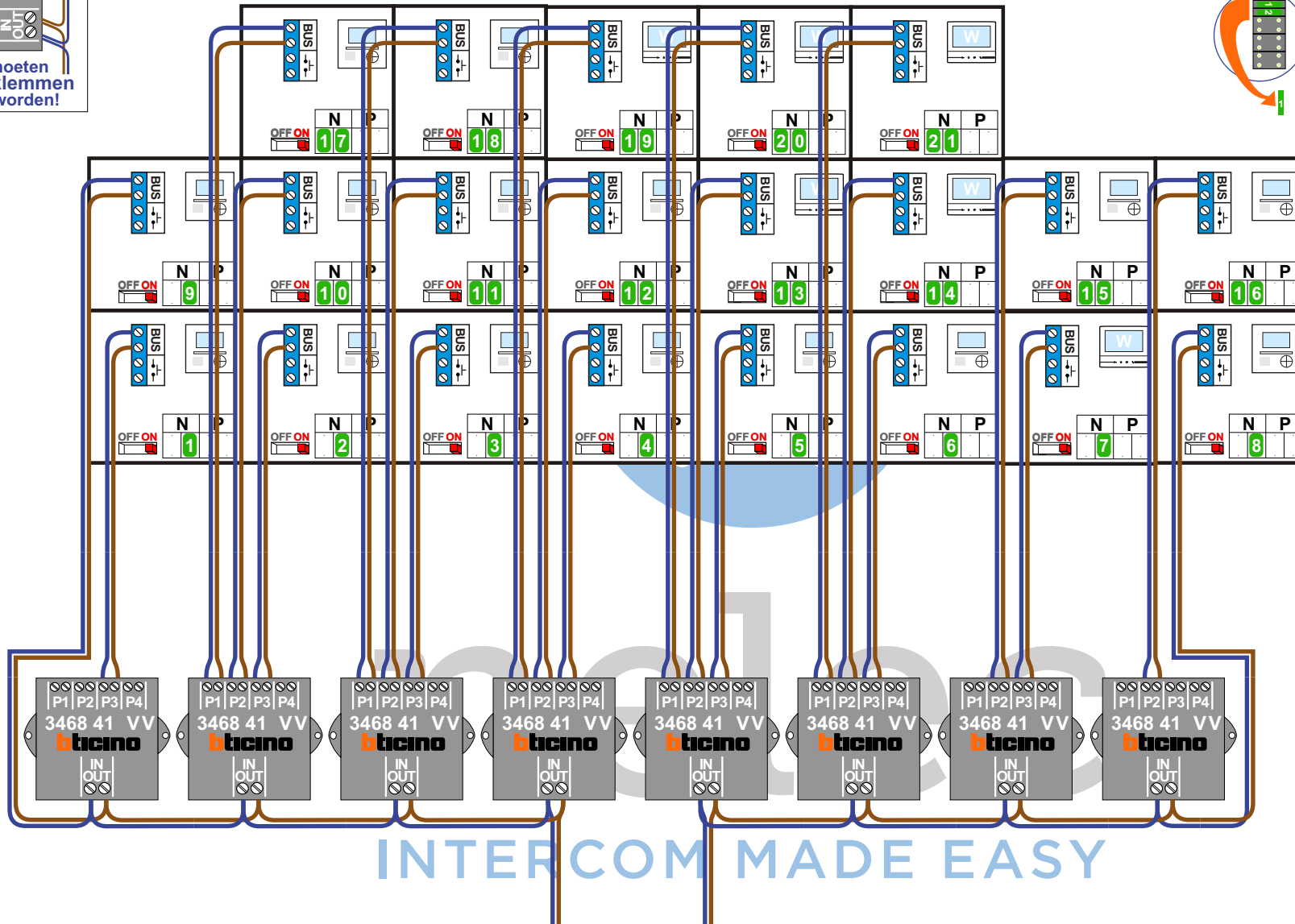

M-70W videofoons krijgen een E-65 hulpvoeding jumper 1 verwijderen

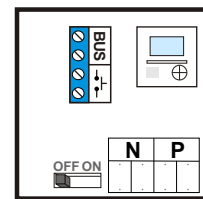

INTERCOM MADE EASY

Van KNOOP pagina 1

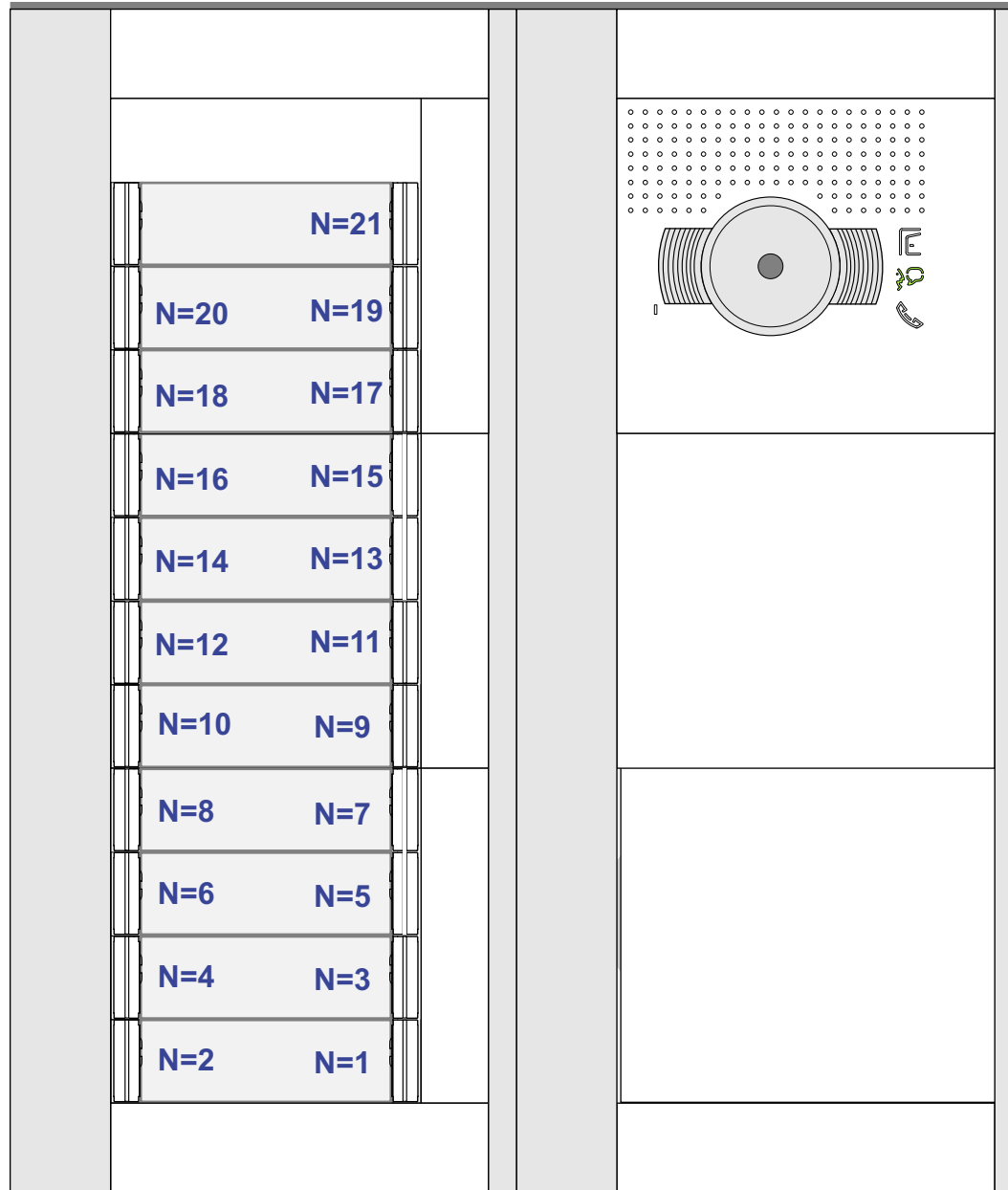

N-waarde	Huisnummer	Switch ON	Videfoon
1	10.1	X	M-43
2	10.2	X	M-43
3	10.3	X	M-43
4	10.4	X	M-43
5	10.5	X	M-43
6	10.6	X	M-43
7	10.7	X	M-70W
8	10.8	X	M-43
9	10.9	X	M-43
10	10.10	X	M-43
11	10.11	X	M-43
12	10.12	X	M-43
13	10.13	X	M-70W
14	10.14	X	M-70W
15	10.15	X	M-43
16	10.16	X	M-43
17	10.17	X	M-43
18	10.18	X	M-43
19	10.19	X	M-70W
20	10.20	X	M-70W
21	10.21	X	M-70W

nelec
INTERCOM MADE EASY