

BUS 2-DRAADS



Bij monteren/demonteren spanning eraf en voorkom defecten!

— = systeemkabel
Bij kabel 2 x 1 mm²:
180% afstand!
Bij kabel 2 x 0,28 mm²:
60% afstand!
UTP op aanvraag.

M-50b

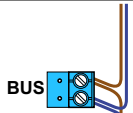

De aders moeten echt OP de connector doorgelust worden!



nelec

INTERCOM MADE EASY

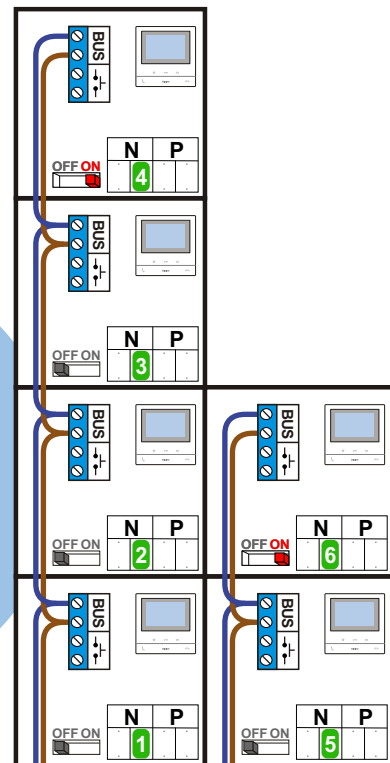

Max. 100 meter systeemkabel tot laatste videofoon

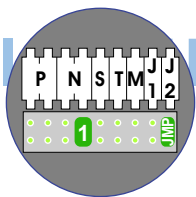

Pot. vrij contact tbv deuropener

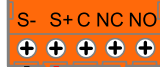

Haal de spanning van het systeem als je een digitizer monteert of demonteert

DEURSTATION S-130V

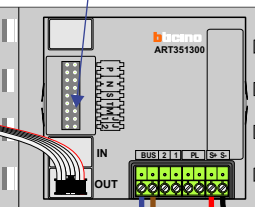

Digitizer voor 1 t/m 8 drukkers

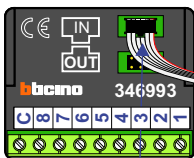

nokjes connectoren wijzen naar elkaar

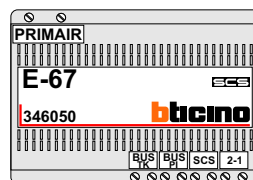

Max. 50 meter