

— = systeemkabel
 Bij andere getwiste kabel **66%** afstand!
 Bij ongetwiste kabel **max. 50 meter** buitenpost naar videofoon.
 UTP op aanvraag.

TWEEDRAADS BUS



Bij monteren/demontieren **spanning eraf** voorkomt defecten!

M-50

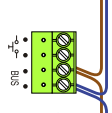

De aders moeten **echt OP de connector** doorgelust worden!

346050 bticino



De twee stijgers **echt OP de klemmen** van E-67 aansluiten!

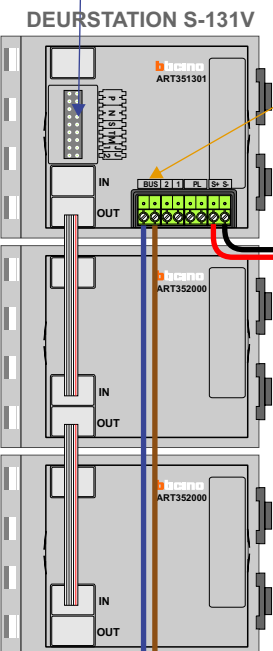
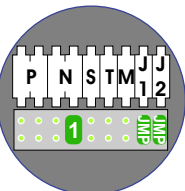
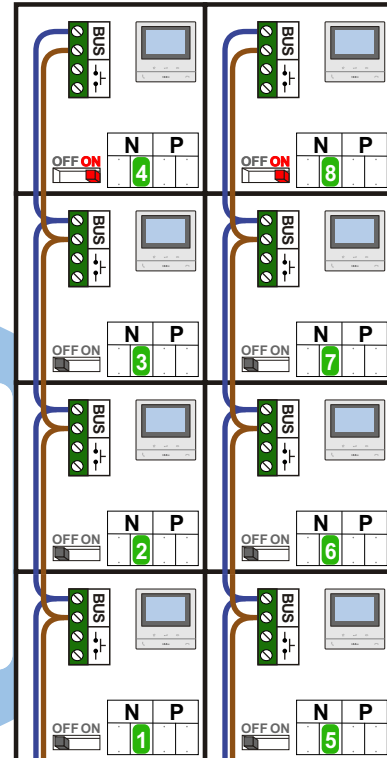

Haal de spanning van het systeem als je een module monteert of demonteert

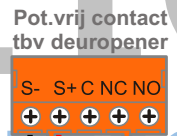

Max. 100 meter systeemkabel tot laatste videofoon

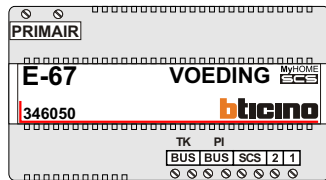

Max. 50 meter

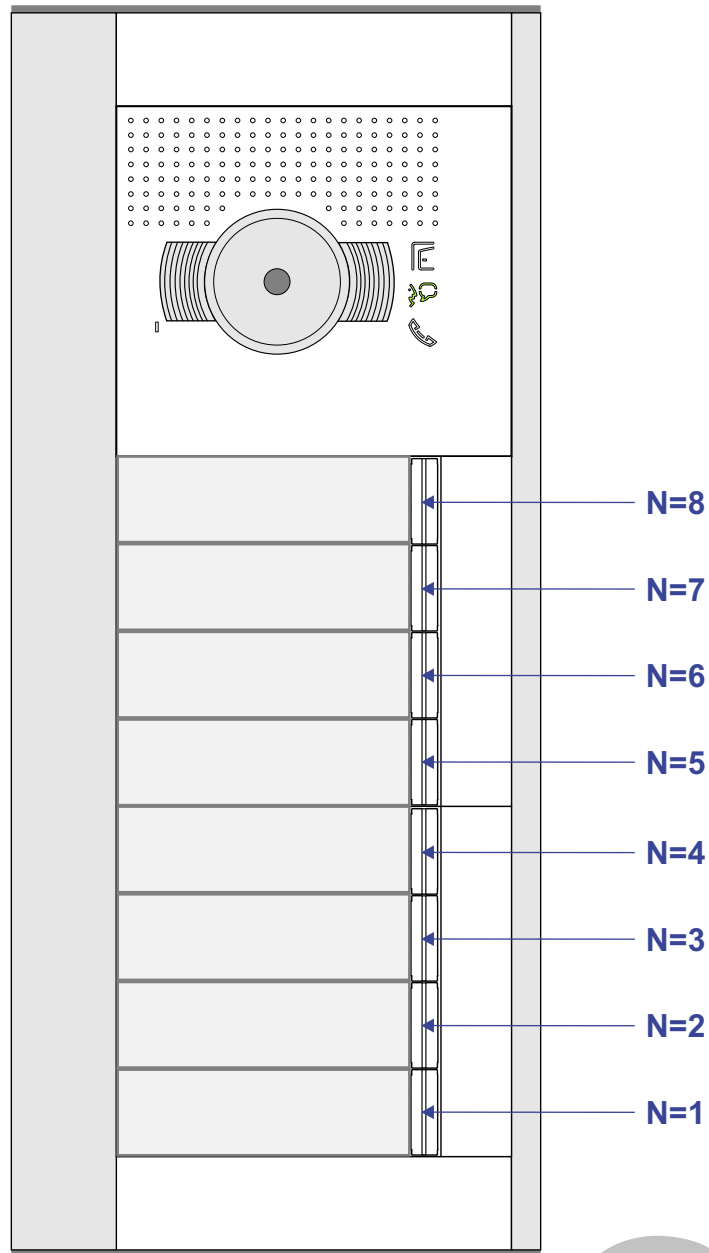

nelec

INTERCOM MADE EASY

N-waarde	Huisnummer	Eindweerstand
1	W1	
2	W4	
3	W7	
4	W10	X
5	W13	
6	W3	
7	W6	
8	W9	X

— = systeemkabel
 Bij andere getwiste kabel **66%** afstand!
 Bij ongetwiste kabel **max. 50 meter** buitenpost naar videfoon.
 UTP op aanvraag.

TWEEDRAADS BUS



Bij monteren/demonteren **spanning eraf** voorkomt defecten!

M-50

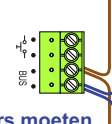

De aders moeten **echt OP de connector** doorgelust worden!

346050 bticino



De twee stijgers **echt OP de klemmen** van E-67 aansluiten!

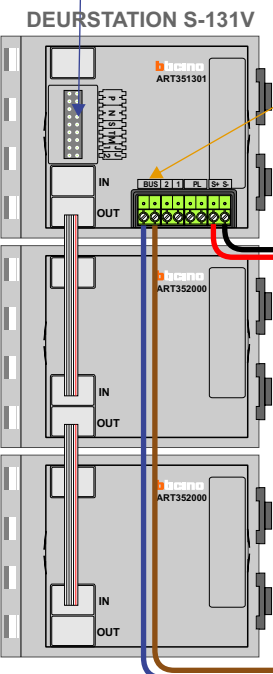
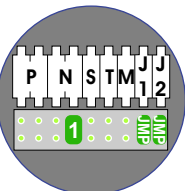

Haal de spanning van het systeem als je een module monteert of demonteert

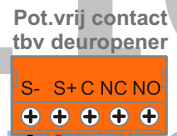

Max. 100 meter systeemkabel tot laatste videfoon

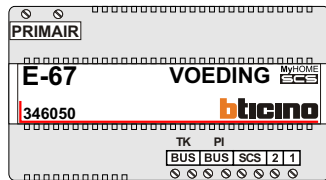

Max. 50 meter

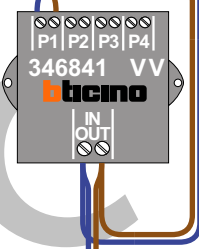
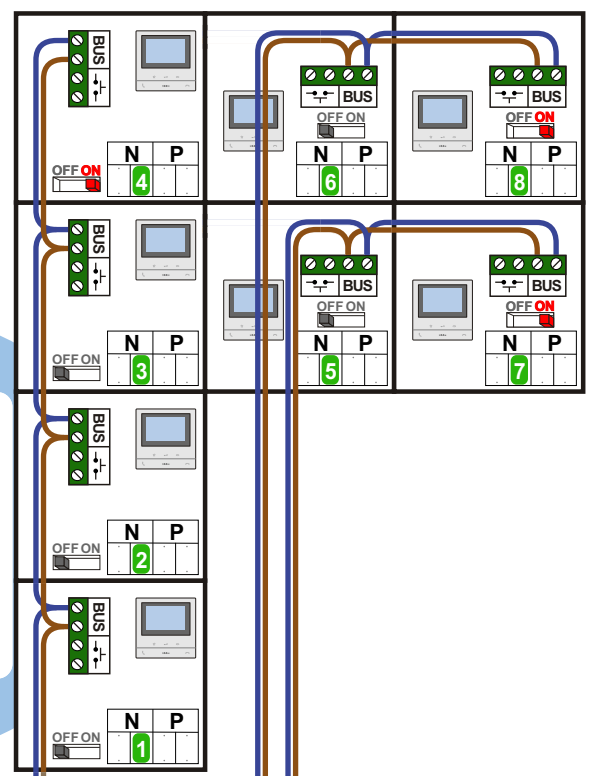

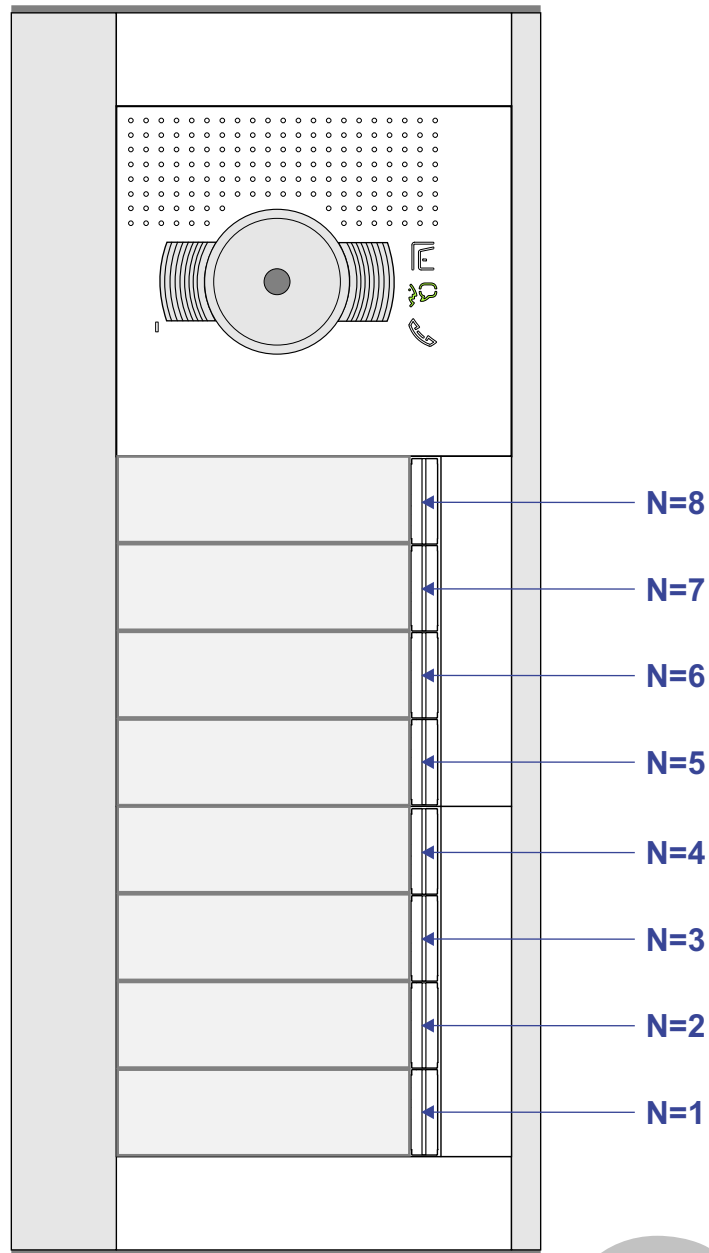

nelec

N-waarde	Huisnummer	Eindweerstand
1	W14	
2	W2	
3	W5	
4	W8	X
5	W11	
6	W12	
7	W15	X
8	W16	X