

**— = systeemkabel**  
Bij andere getwiste kabel **66%** afstand!  
Bij ongetwiste kabel **max. 50 meter** buitenpost naar videofoon.  
UTP op aanvraag.

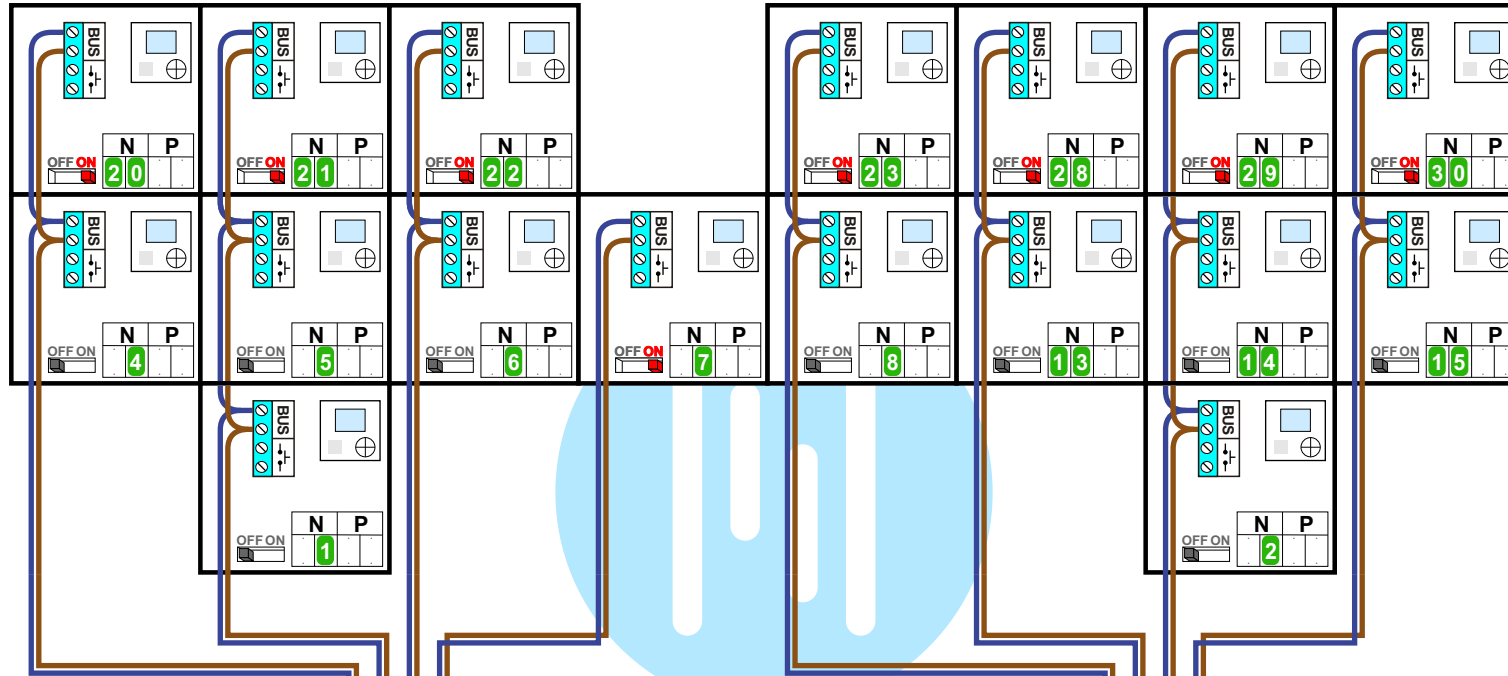
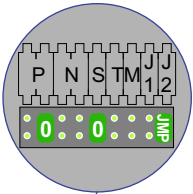

**VideoVerdeler**  
  
De aders moeten **echt OP** de klemmen doorgelust worden!

**M-40**  
  
De aders moeten **echt OP** de connector doorgelust worden!

**BUITENPOST S-140V**

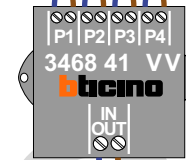
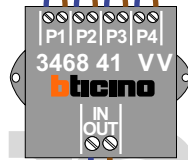
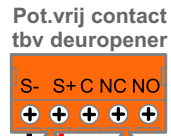
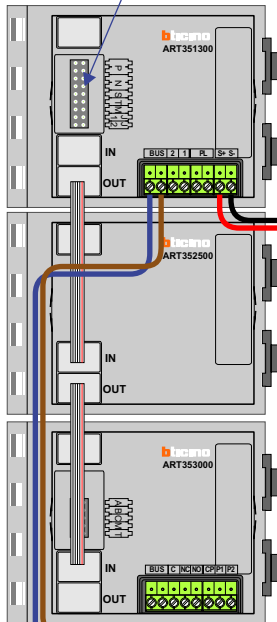

**Max. 50 meter**

**Max. 100 meter systeemkabel tot laatste videofoon**

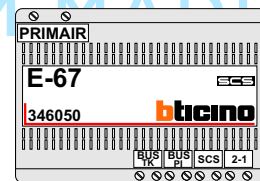

Naar VV pagina 2

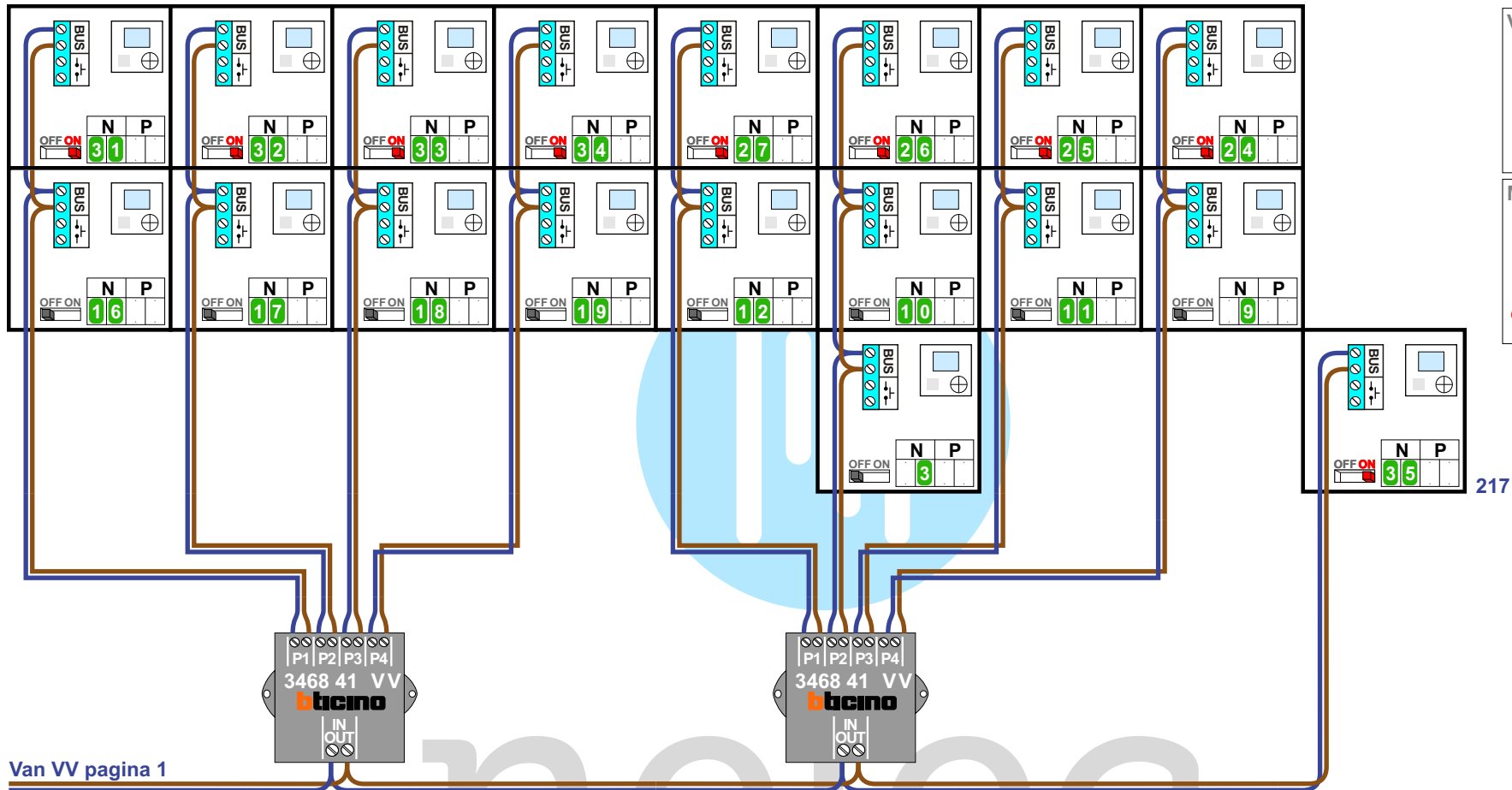

**VideoVerdeler**

De aders moeten echt OP de klemmen doorgelust worden!

**M-40**

De aders moeten echt OP de connector doorgelust worden!

Van VV pagina 1

**nelec**  
INTERCOM MADE EASY

N-waarde	Huisnummer	Switch ON
1	14	
2	34	
3	42	
4	44	
5	46	
6	48	
7	50	
8	52	
9	54	
10	56	
11	58	
12	60	
13	62	
14	64	
15	66	
16	68	
17	70	
18	72	
19	74	
20	76	X
21	78	X
22	80	X
23	82	X
24	84	X
25	86	X
26	88	X
27	90	X
28	92	X
29	94	X
30	96	X
31	98	X
32	100	X
33	102	X
34	104	X
35	217	X

nelec  
INTERCOM MADE EASY