

— = systeemkabel
Bij andere getwiste kabel 66% afstand!
Bij ongetwiste kabel max. 50 meter buitenpost naar videofoon.
UTP op aanvraag.

BUS 2-DRAADS

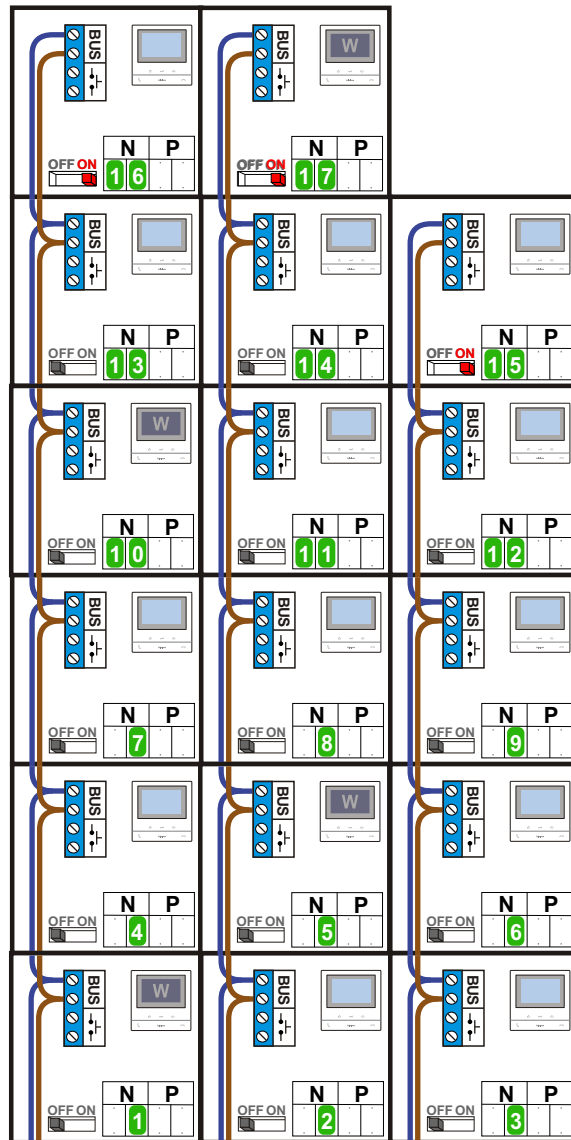

Bij monteren/demonteren spanning eraf en voorkom defecten!



Haal de spanning van het systeem als je een digitizer monteert of demonteert

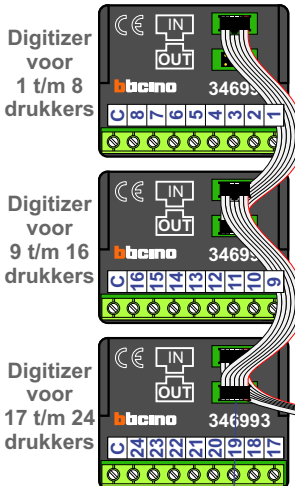

nokjes connectoren wijzen naar elkaar

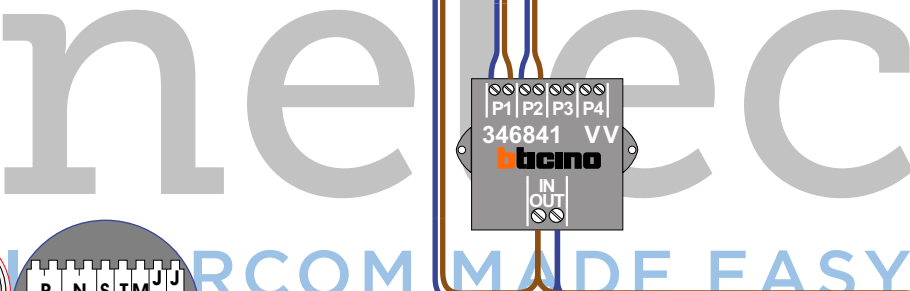

Pot.vrij contact tbv deuropener

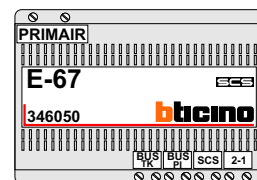
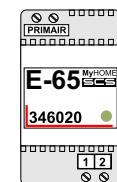
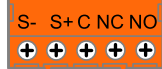

gepolariseerd

Max. 50 meter

Max. 100 meter systeemkabel tot laatste videofoon

N-waarde	Huisnummer	Eindschakelaar	Videfoon
1	148		M-50WiFi
2	150		M-50b
3	152		M-50b
4	154		M-50b
5	156		M-50WiFi
6	158		M-50b
7	160		M-50b
8	162		M-50b
9	164		M-50b
10	166		M-50WiFi
11	168		M-50b
12	170		M-50b
13	172		M-50b
14	174		M-50b
15	176	X	M-50b
16	178	X	M-50b
17	180	X	M-50WiFi

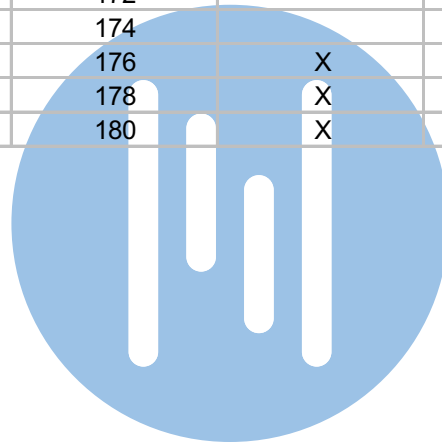

nelec
INTERCOM MADE EASY