

**BUS 2-DRAADS**



Bij monteren/demonteren spanning eraf en voorkom defecten!

**— = systeemkabel**  
Bij kabel 2 x 1 mm<sup>2</sup>: 180% afstand!  
Bij kabel 2 x 0,28 mm<sup>2</sup>: 60% afstand!  
UTP op aanvraag.

**M-70**



Videofoon werkt pas na instellen van taal, datum en tijd.

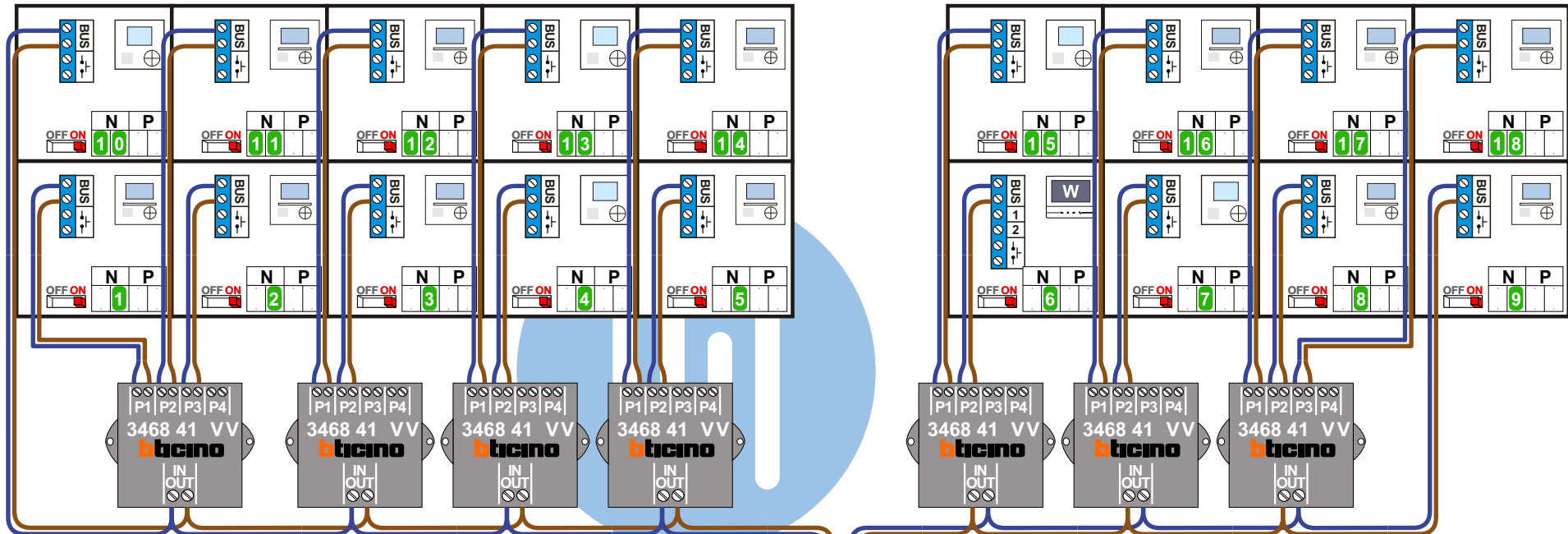

**DEURSTATION S-10A**

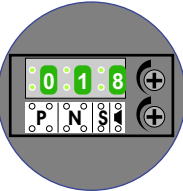
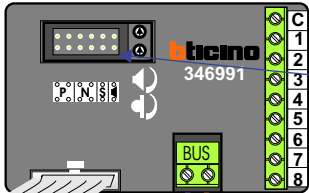

Digitizer voor 1 t/m 8 drukkers

Digitizer voor 9 t/m 16 drukkers

Digitizer voor 17 t/m 24 drukkers

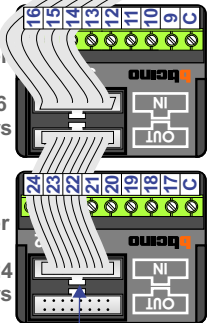

**nokje connector altijd binnenkant!**

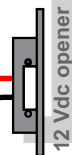

Max. 100 meter systeemkabel tot laatste videofoon

Max. 50 meter

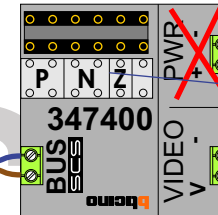

Camera een eigen voeding geven!

mantel coax  
kern coax  
max. 3 meter coax

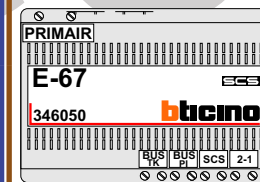
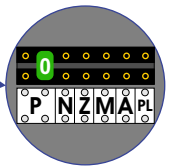

Max. 290 meter

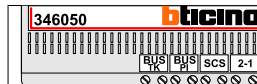

De twee stijgers echt OP de klemmen van E-67 aansluiten!

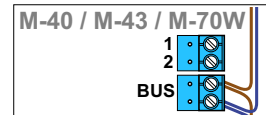

De aders moeten echt OP de connector doorgelust worden!



De aders moeten echt OP de klemmen doorgelust worden!

N-Waarde	Huisnummer	Switch On	Toestel
1	101	X	M-43
2	102	X	M-43
3	103	X	M-43
4	104	X	M-40
5	105	X	M-43
6	106	X	M-70W
7	107	X	M-40
8	108	X	M-43
9	109	X	M-43
10	201	X	M-40
11	202	X	M-43
12	203	X	M-43
13	204	X	M-40
14	205	X	M-43
15	206	X	M-40
16	207	X	M-43
17	208	X	M-43
18	209	X	M-43

nelec  
INTERCOM MADE EASY