

— = systeemkabel
Bij andere getwiste kabel 66% afstand!
Bij ongetwiste kabel max. 50 meter buitenpost naar videofoon.
UTP op aanvraag.

BUS 2-DRAADS



Bij monteren/demonteren spanning eraf en voorkom defecten!

M-40



De aders moeten echt **OP** de connector doorgelust worden!

VideoVerdeler



De aders moeten echt **OP** de klemmen doorgelust worden!

346050

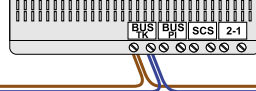

De twee buitenposten echt **OP** de klemmen van E-67 aansluiten!

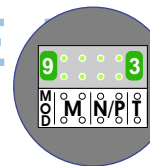
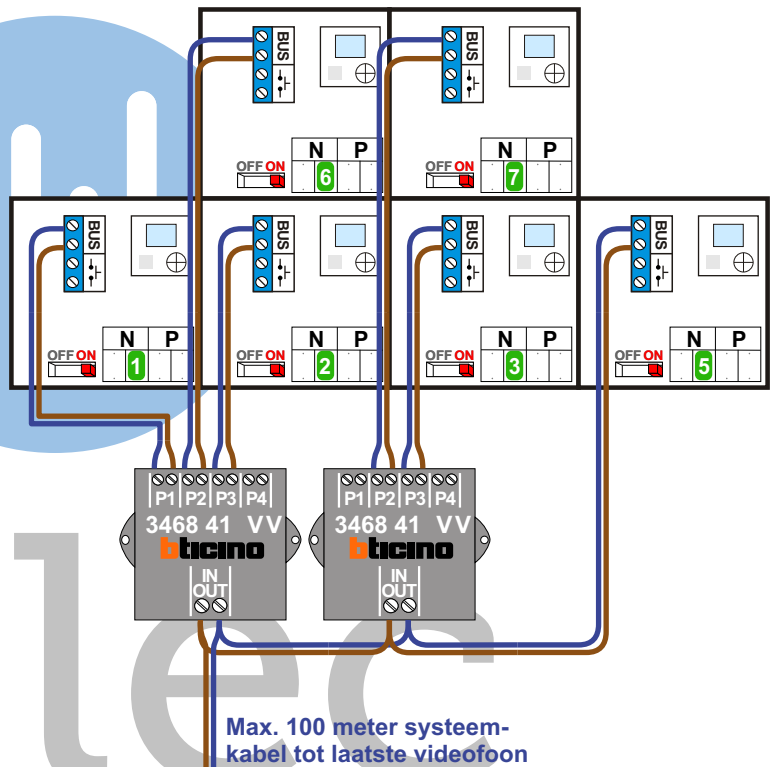
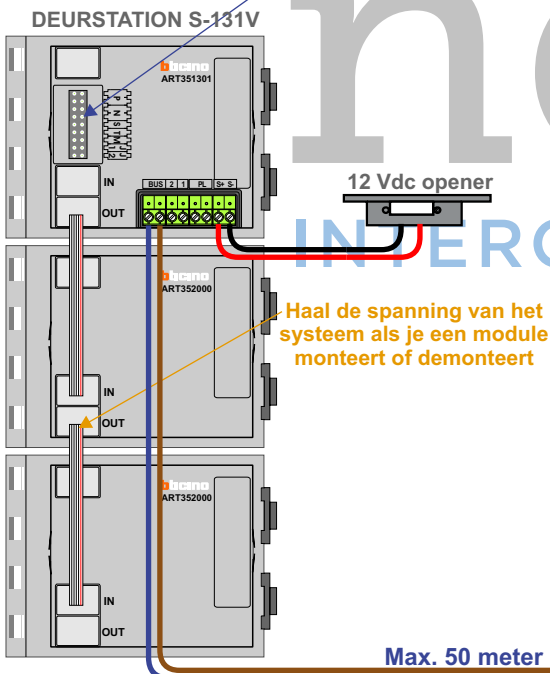
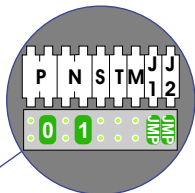
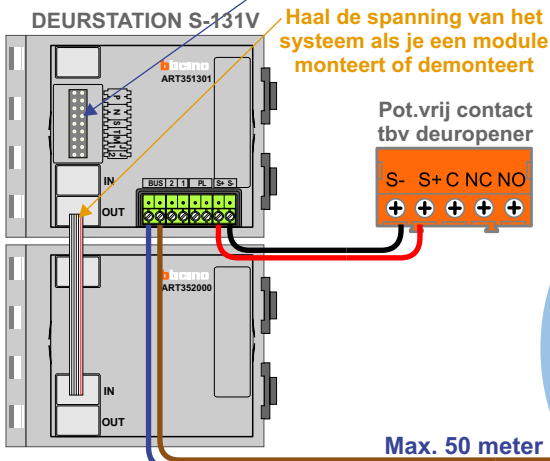
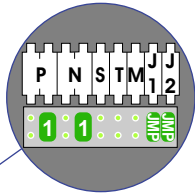

Algemene Bel Contact N.O.

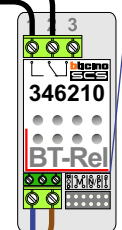
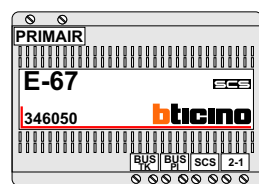
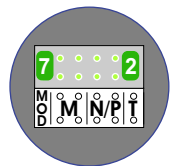

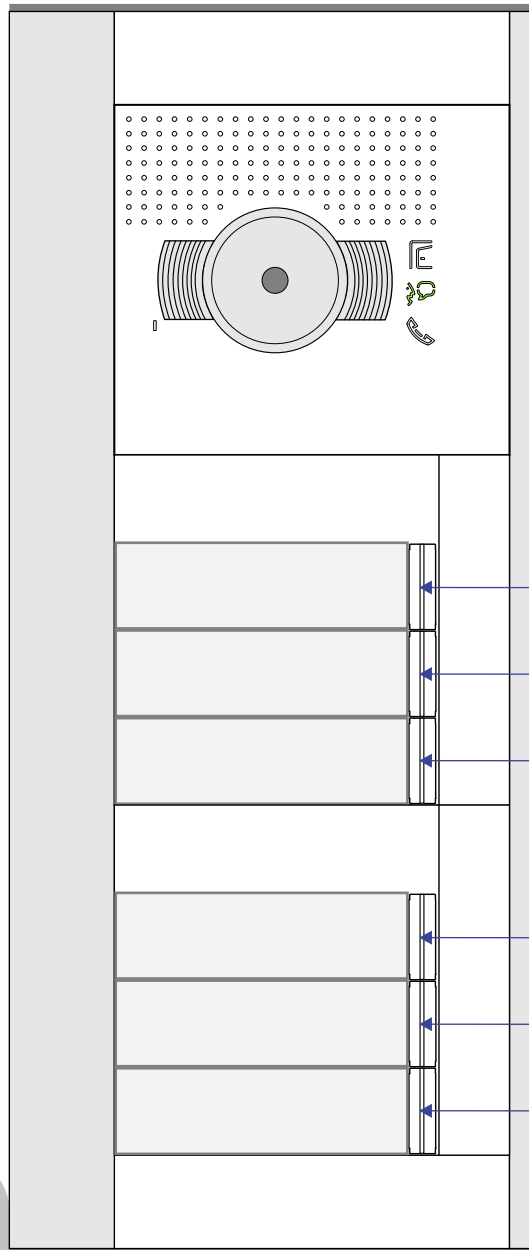

N=8

N=7

N=6

N=5

N=4

N=3

N=2

N=1

nelec

INTERCOM MADE EASY

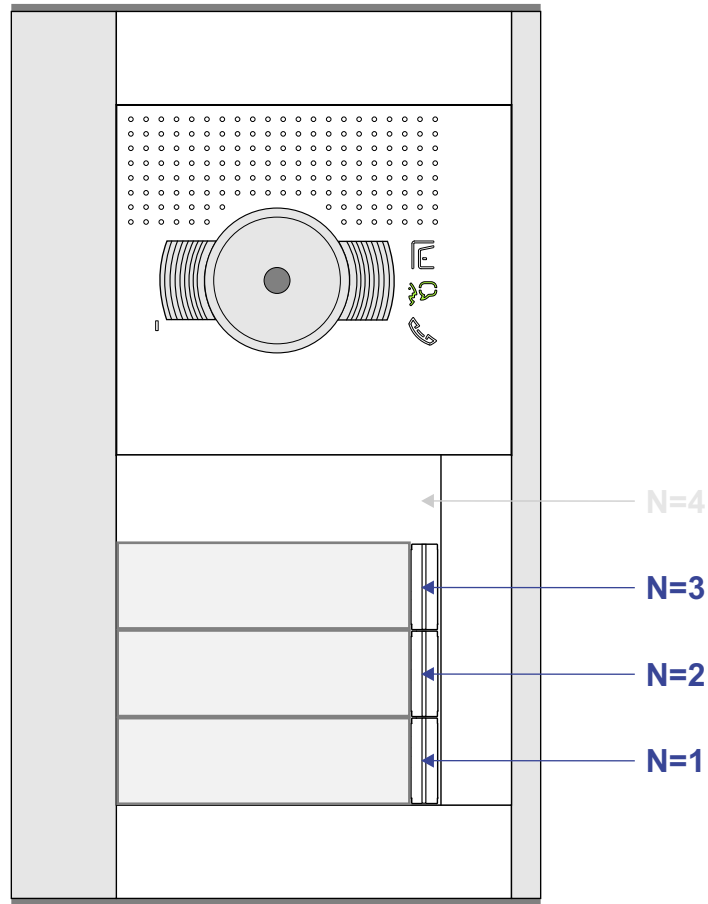

nelec
INTERCOM MADE EASY