

— = systeemkabel
 Bij andere getwiste kabel **66%** afstand!
 Bij ongetwiste kabel **max. 50 meter** buitenpost naar videofoon.
 UTP op aanvraag.

TWEEDRAADS BUS



Bij monteren/demonteren **spanning eraf** voorkomt defecten!

VideoVerdelers

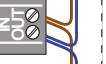

De aders moeten **echt OP** de klemmen doorgelust worden!

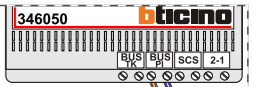

De twee stijgers **echt OP** de klemmen van E-67 aansluiten!

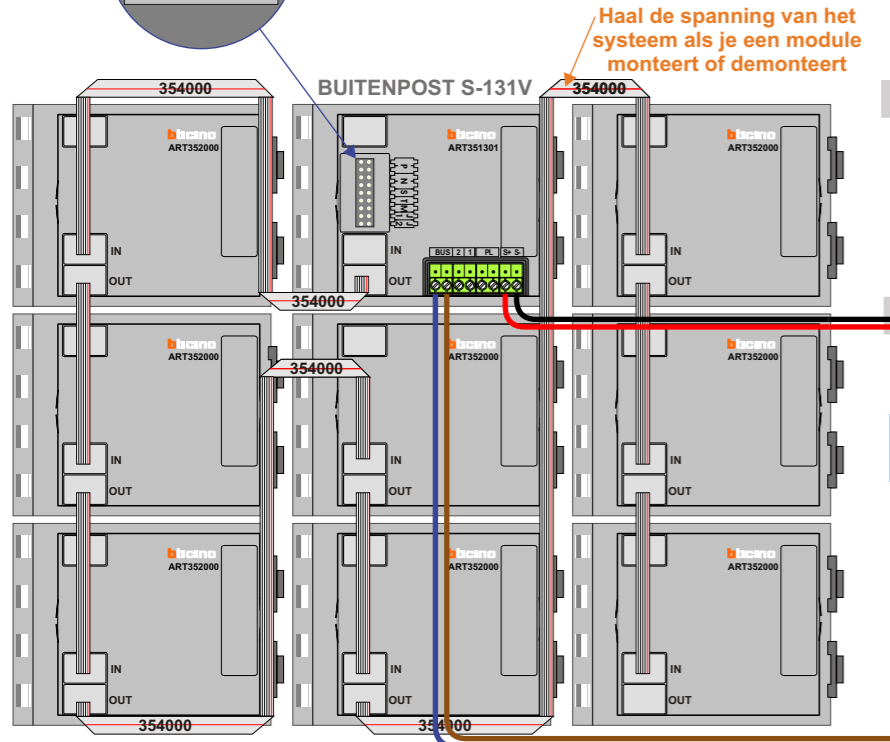
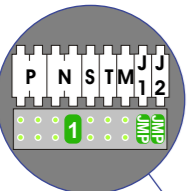
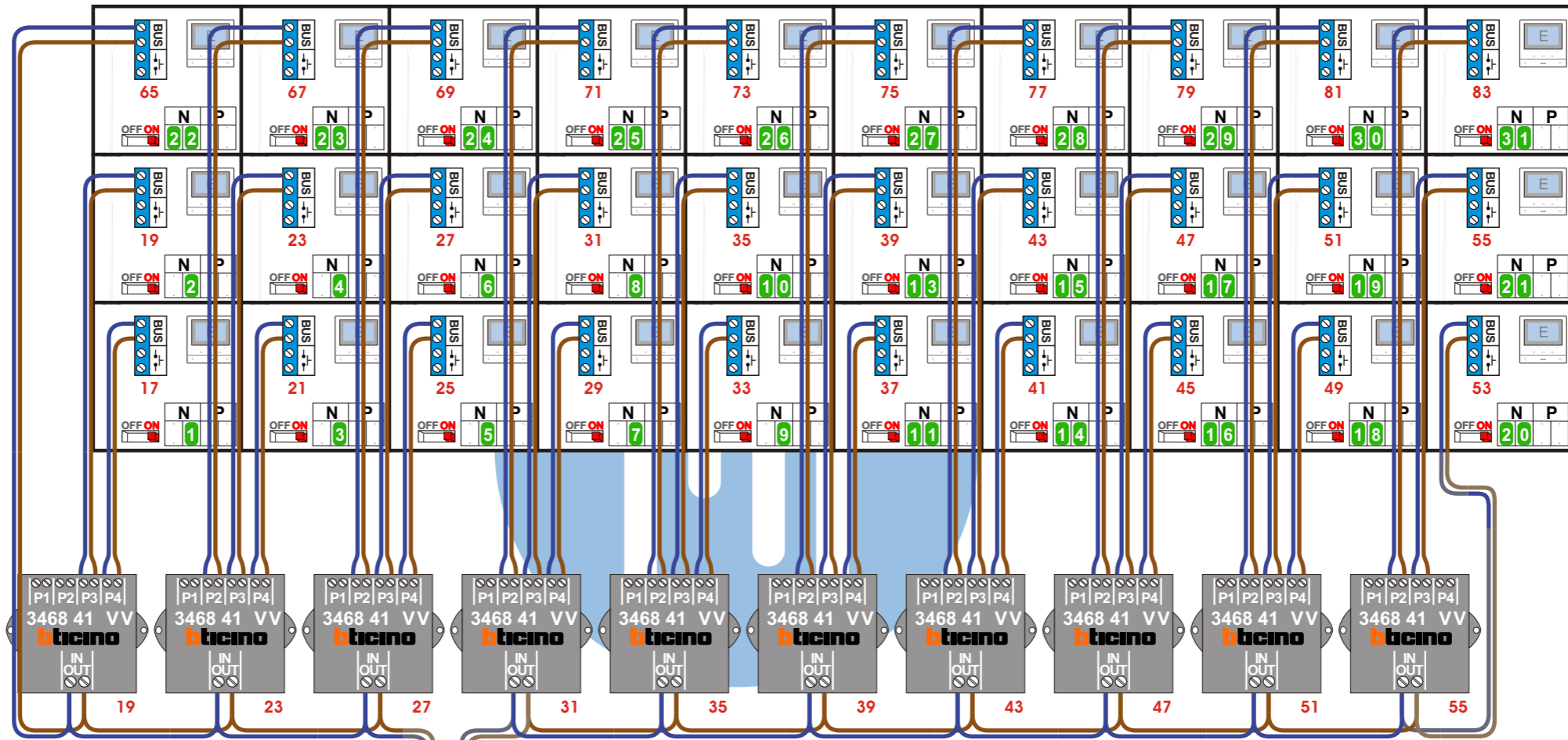

Haal de spanning van het systeem als je een module monteert of demonteert

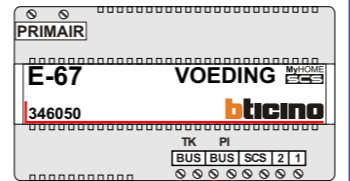

Max. 50 meter

Max. 100 meter systeemkabel tot laatste videofoon

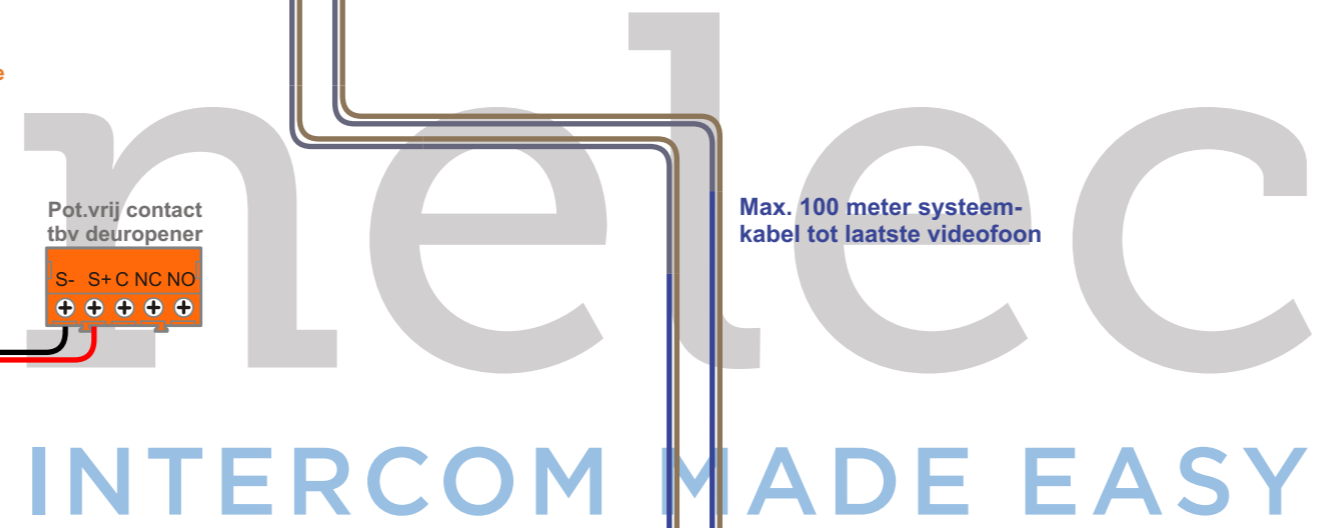

N-Waarde	Huisnummers	Eindweerstand
1	17	X
2	19	X
3	21	X
4	23	X
5	25	X
6	27	X
7	29	X
8	31	X
9	33	X
10	35	X
11	37	X
13	39	X
14	41	X
15	43	X
16	45	X
17	47	X
18	49	X
19	51	X
20	53	X
21	55	X
22	65	X
23	67	X
24	69	X
25	71	X
26	73	X
27	75	X
28	77	X
29	79	X
30	81	X
31	83	X

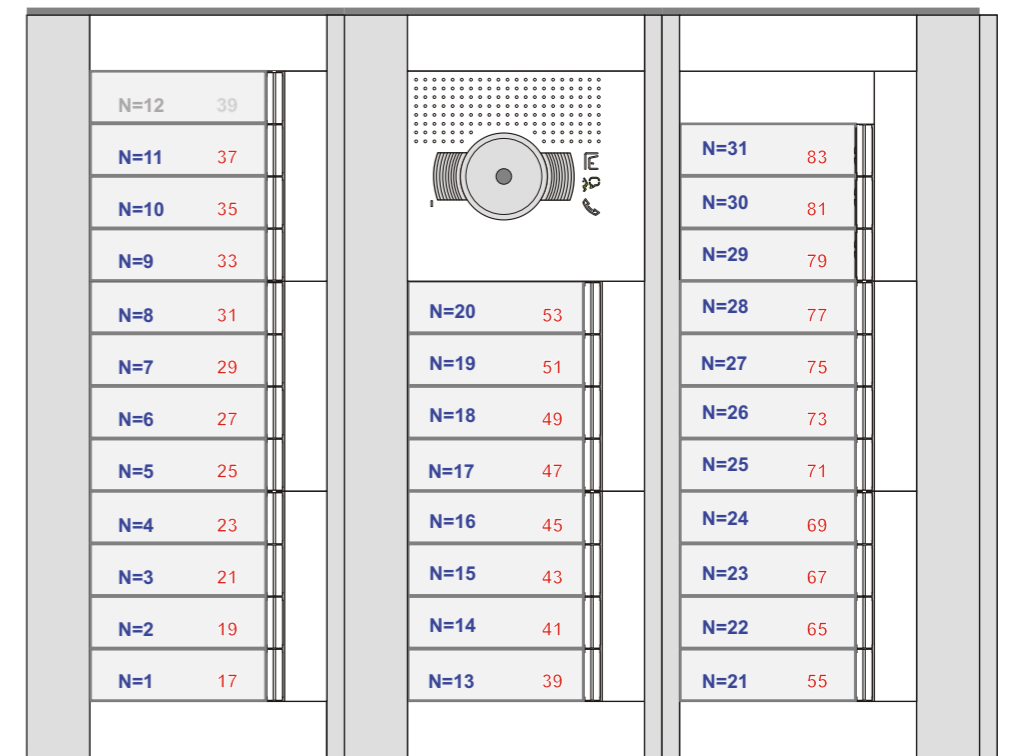

nelec
INTERCOM MADE EASY