

**— = systeemkabel**  
 Bij andere getwiste kabel 66% afstand!  
 Bij ongetwiste kabel max. 50 meter buitenpost naar videofoon.  
 UTP op aanvraag.

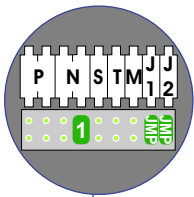

**BUS 2-DRAADS**

Bij monteren/demonteren spanning eraf en voorkom defecten!

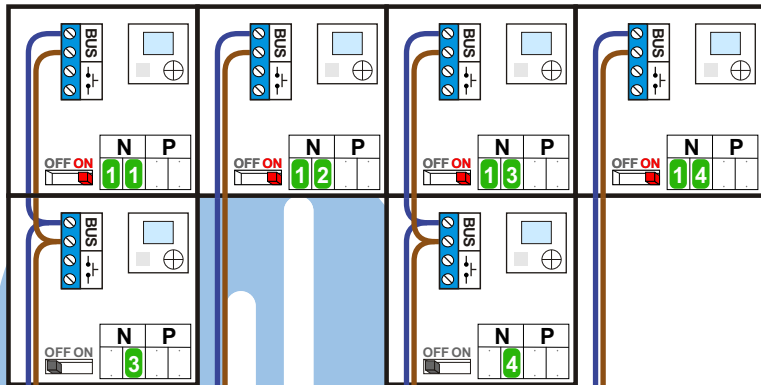

Haal de spanning van het systeem als je een module monteert of demonteert

DEURSTATION S-131V

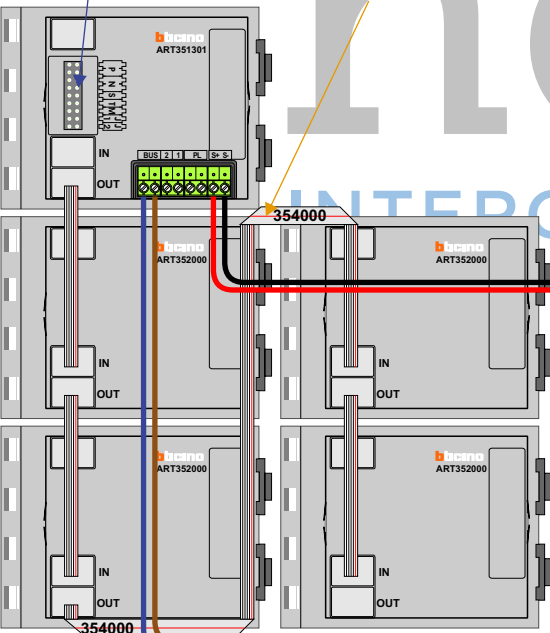

Pot.vrij contact tbv deur opener

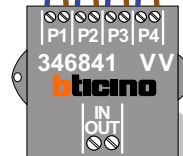

Max. 100 meter systeemkabel tot laatste videofoon

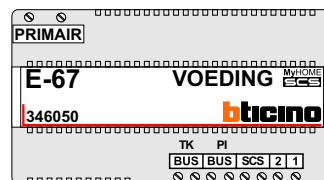

Max. 50 meter

**— = systeemkabel**  
 Bij andere getwiste kabel 66% afstand!  
 Bij ongetwiste kabel max. 50 meter buitenpost naar videofoon.  
 UTP op aanvraag.



**BUS 2-DRAADS**

Bij monteren/demonteren spanning eraf en voorkom defecten!

**VideoVerdeler**

De aders moeten echt **OP** de klemmen doorgelust worden!

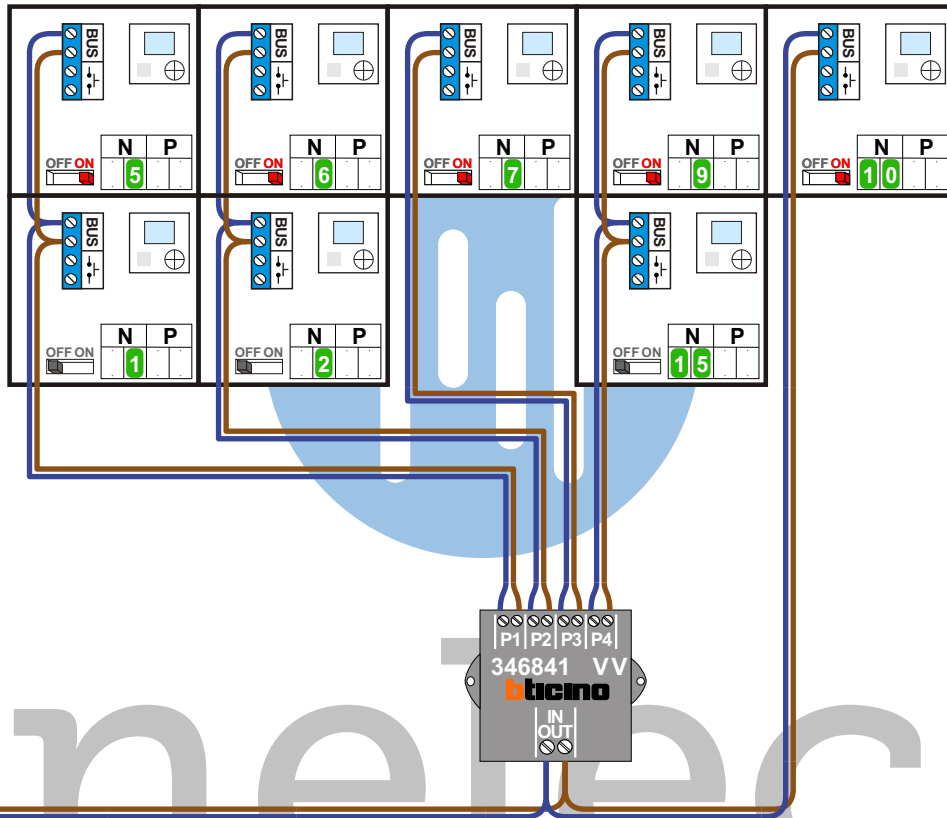

INTERCOM MADE EASY

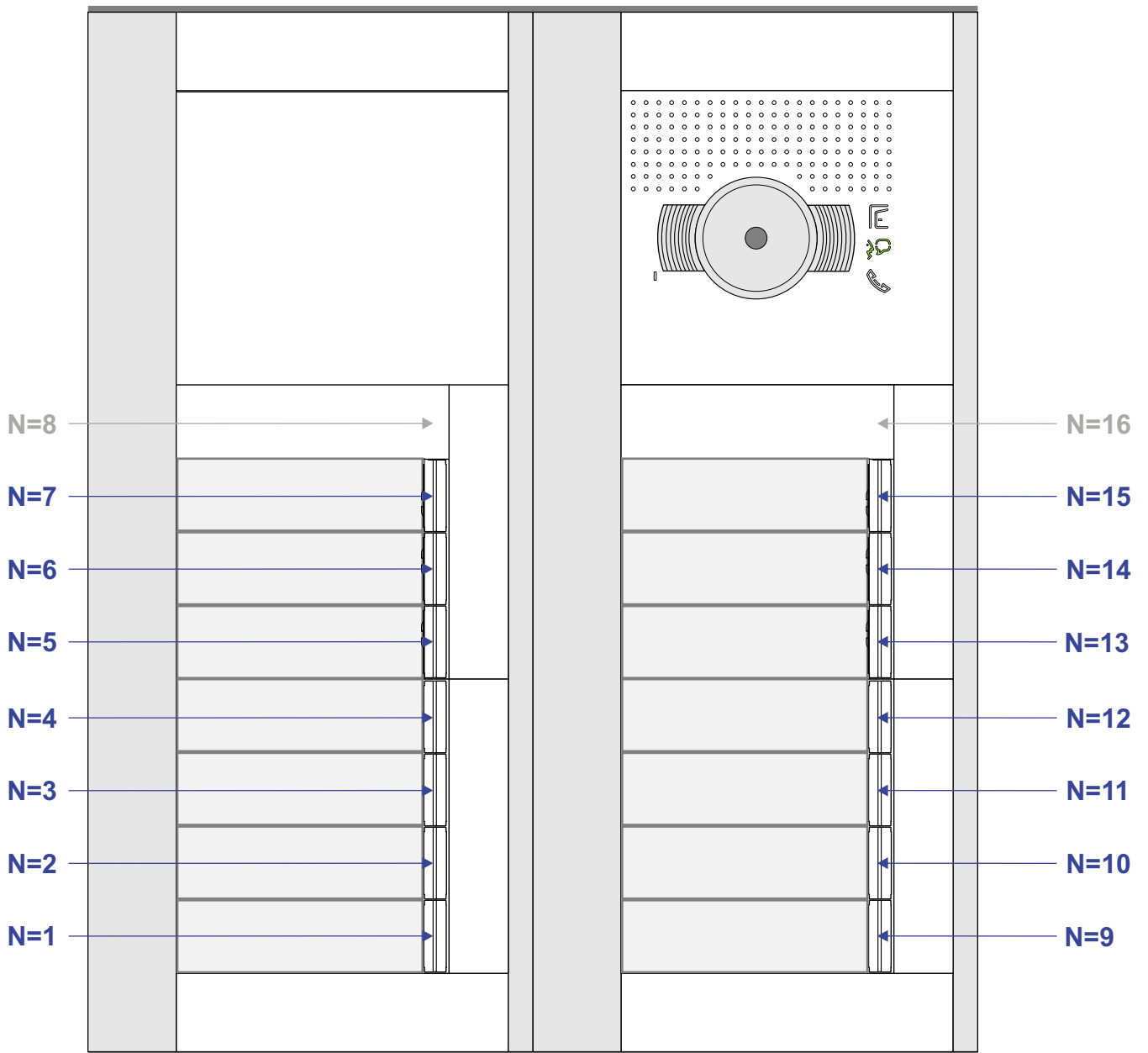

N-Waarde	Appartement
1	1
2	2
3	3
4	4
5	5
6	6
7	7
9	8
10	9
11	10
12	11
13	12
14	13
15	14