

— = systeemkabel
 Bij kabel 2 x 1 mm²:
 180% afstand!
 Bij kabel 2 x 0,28 mm²:
 60% afstand!
 UTP op aanvraag.

BUS 2-DRAADS

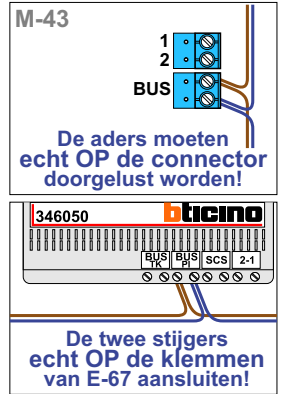

Bij monteren/demonteren
 spanning eraf
 en voorkom defecten!



nelec
 INTERCOM MADE EASY

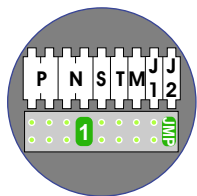
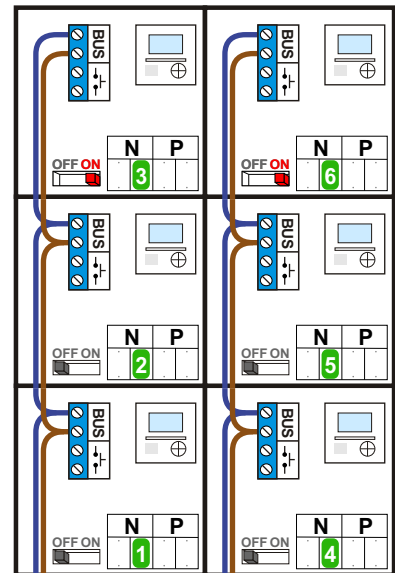

Haal de spanning van het
 systeem als je een module
 monteert of demonteert

Pot.vrij contact
 tbv deuropener

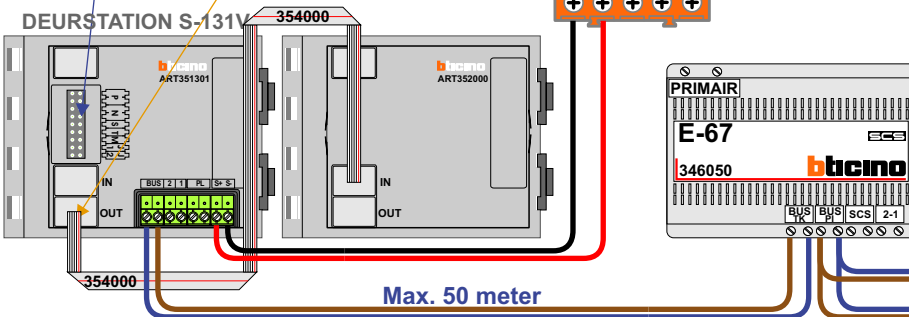
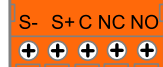

Max. 100 meter systeem-
 kabel tot laatste videofoon

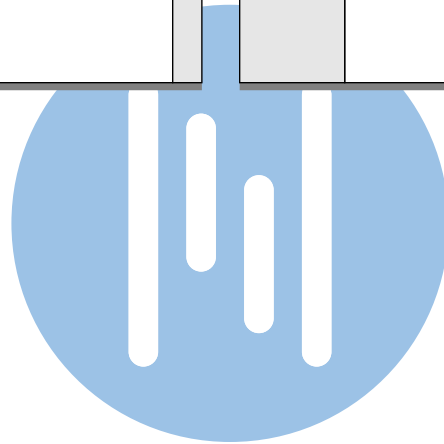
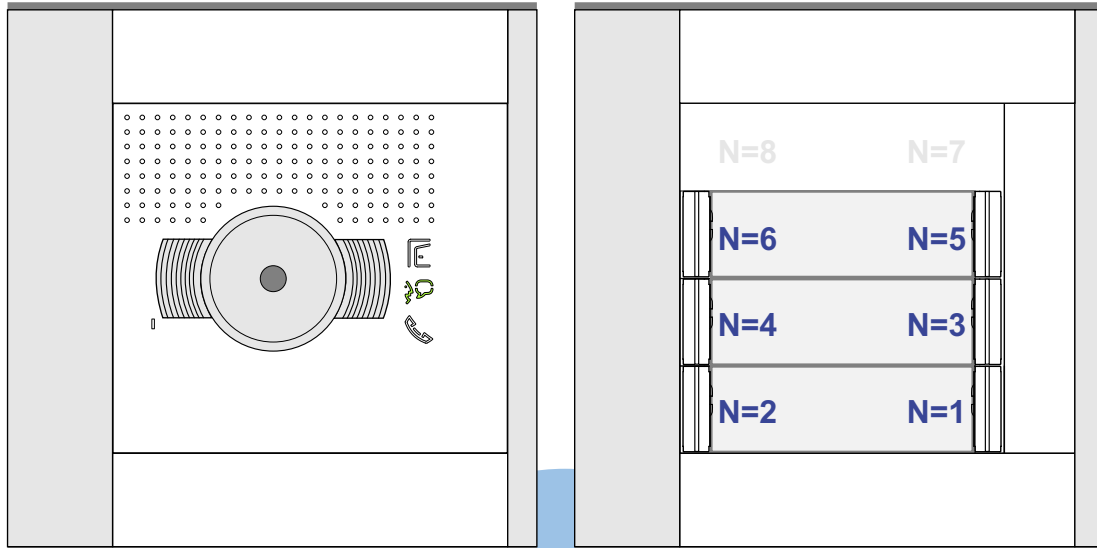

nelec
INTERCOM MADE EASY