

**BUS 2-DRAADS**



Bij monteren/demonteren spanning eraf en voorkom defecten!

**— = systeemkabel**

Bij andere getwiste kabel 66% afstand!  
Bij ongetwiste kabel max. 50 meter buitenpost naar videofoon.  
UTP op aanvraag.

**VideoVerdeler**

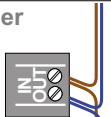

De aders moeten echt OP de klemmen doorgelust worden!

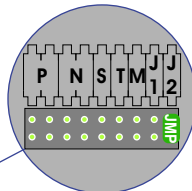

**DEURSTATION S-140V**

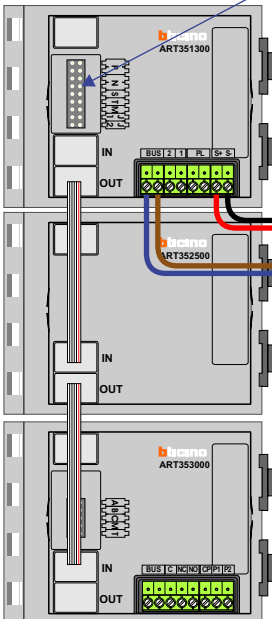

Pot.vrij contact tbv deuropener

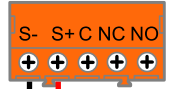

Kabels naar Pagina 2

Kabels naar Pagina 3

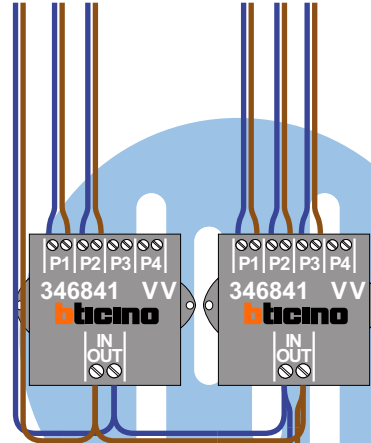

Max. 100 meter systeemkabel tot laatste videofoon

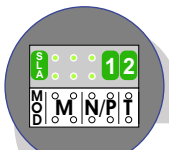

Relais voor extra-bel schakelt 3 sec. met N=1

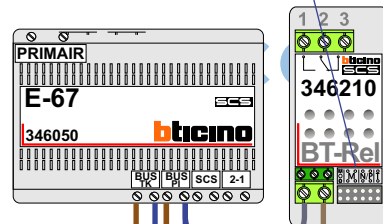

Max. 50 meter

N-Waarde	Huisnummer	Switch-ON	Slave
1	121 Kantoor		
1	121 Slaapwacht		X
1	121 Woonkamer 1		X
1	121 Woonkamer 2		X
1	121 Woonkamer 3	X	X
1	121 Woonkamer 4	X	X
2	123	X	
3	125		
4	127		
5	129		
6	131		
7	133		
8	135		
9	137		
10	139		
11	141		
12	143		
13	145	X	
14	147		
15	149		
16	151		
17	153		
18	155	X	
19	157		
20	159		
21	161		
22	163		
23	165		
24	167		
25	169		
26	171		
27	173		
28	175	X	
29	177		
30	179		
31	181		
32	183		
33	185		

**BUS 2-DRAADS**



Bij monteren/demonteren  
spanning eraf  
en voorkom defecten!

**— = systeemkabel**  
Bij andere getwiste  
kabel 66% afstand!  
Bij ongetwiste kabel  
max. 50 meter buiten-  
post naar videofoon.  
UTP op aanvraag.

**M-50b**

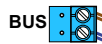

De aders moeten  
echt OP de connector  
doorgelust worden!

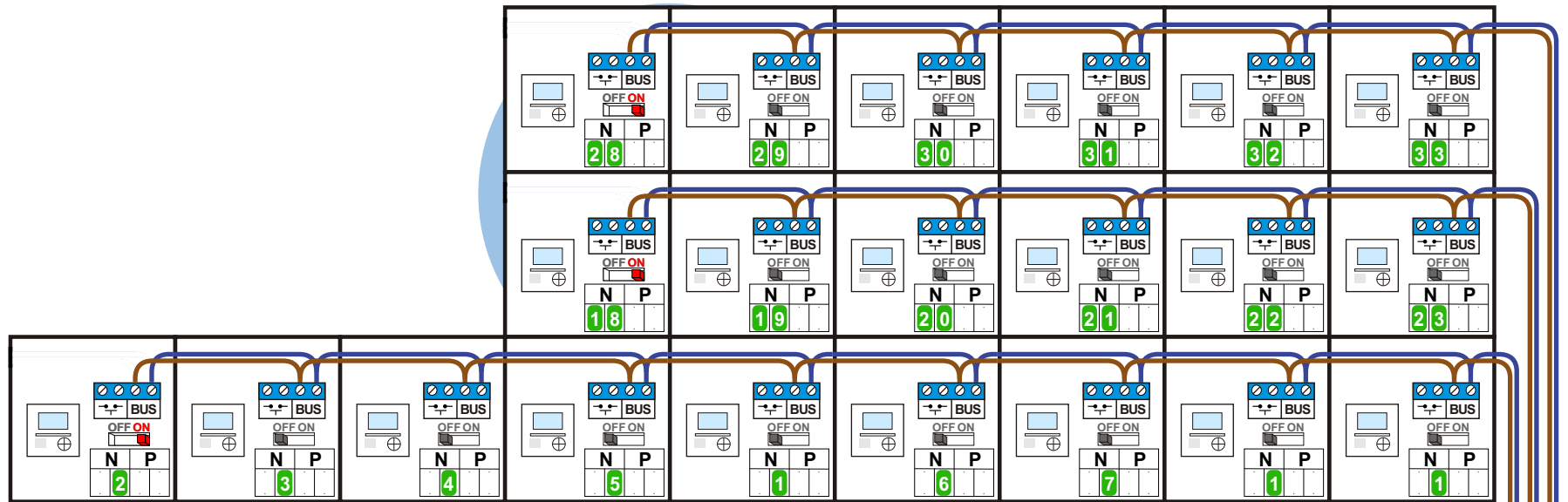

nelec  
INTERCOM MADE EASY

**BUS 2-DRAADS**



Bij monteren/demonteren  
spanning eraf  
en voorkom defecten!

**— = systeemkabel**

Bij andere getwiste  
kabel 66% afstand!  
Bij ongetwiste kabel  
max. 50 meter buiten-  
post naar videofoon.  
UTP op aanvraag.

**M-50b**

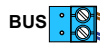

De aders moeten  
echt **OP** de connector  
doorgelust worden!

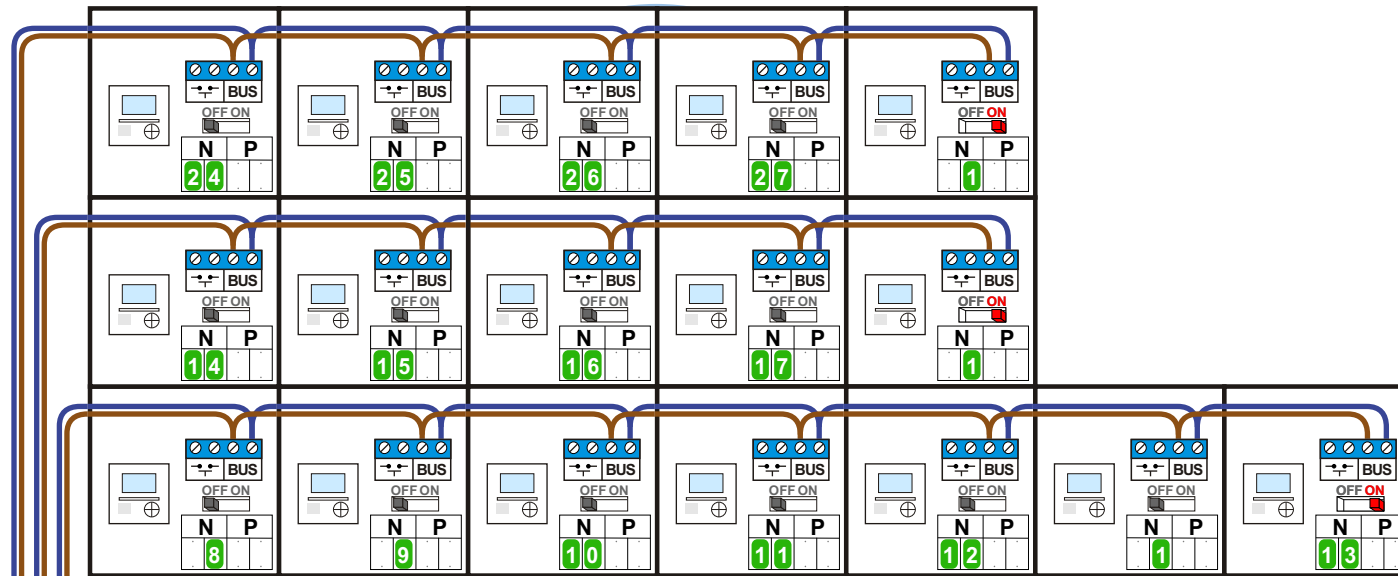

Kabels van  
Pagina 1

nelec  
INTERCOM MADE EASY