

— = systeemkabel
Bij andere getwiste kabel 66% afstand!
Bij ongetwiste kabel max. 50 meter buitenpost naar videofoon.
UTP op aanvraag.

Bij installaties zonder beeld maakt het niet uit hoe je de bus aansluit. De telefoons hoeven niet in serie en eindweerstand zijn niet nodig.

BUS 2-DRAADS



Bij monteren/demonteren spanning eraf en voorkom defecten!

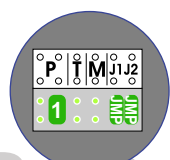
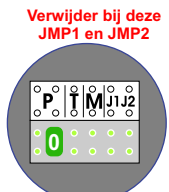
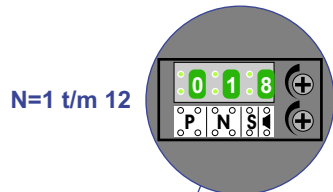
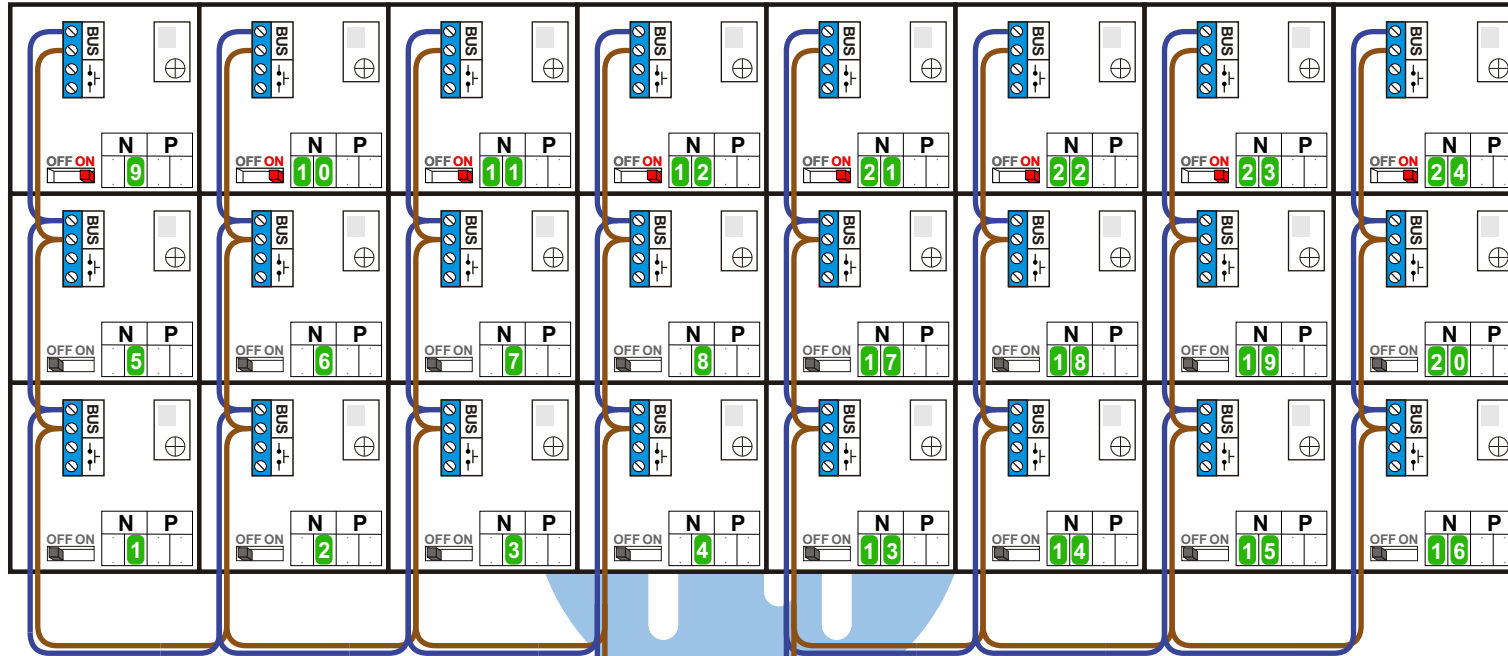

Max. 320 meter systeemkabel tot laatste deurtelefoon

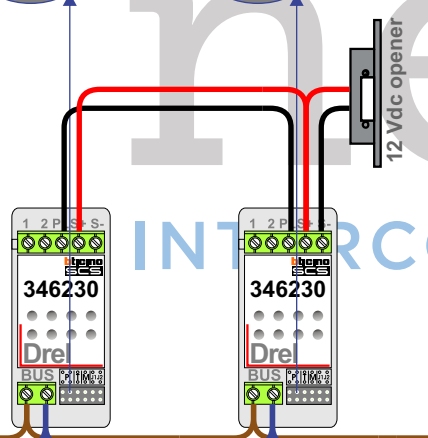
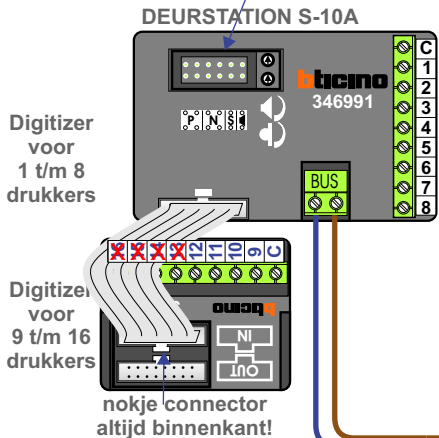
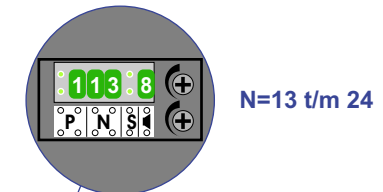

Max. 290 mtr.

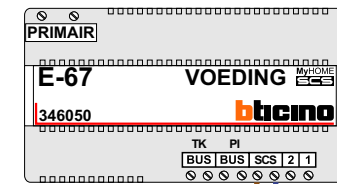
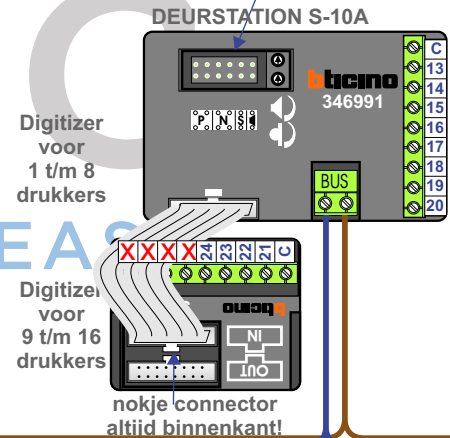

N-waarde	Huisnummer	Switch ON
1	97	
2	99	
3	101	
4	103	
5	105	
6	107	
7	109	
8	111	
9	113	X
10	115	X
11	117	X
12	119	X
13	121	
14	123	
15	125	
16	127	
17	129	
18	131	
19	133	
20	135	
21	137	X
22	139	X
23	141	X
24	143	X

nelec
 INTERCOM MADE EASY

— = systeemkabel
Bij andere getwiste kabel 66% afstand!
Bij ongetwiste kabel max. 50 meter buitenpost naar videofoon.
UTP op aanvraag.

Bij installaties zonder beeld maakt het niet uit hoe je de bus aansluit. De telefoons hoeven niet in serie en eindweerstand zijn niet nodig.

BUS 2-DRAADS



Bij monteren/demonteren spanning eraf en voorkom defecten!

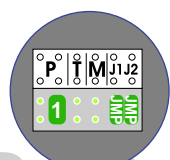
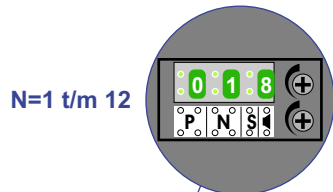
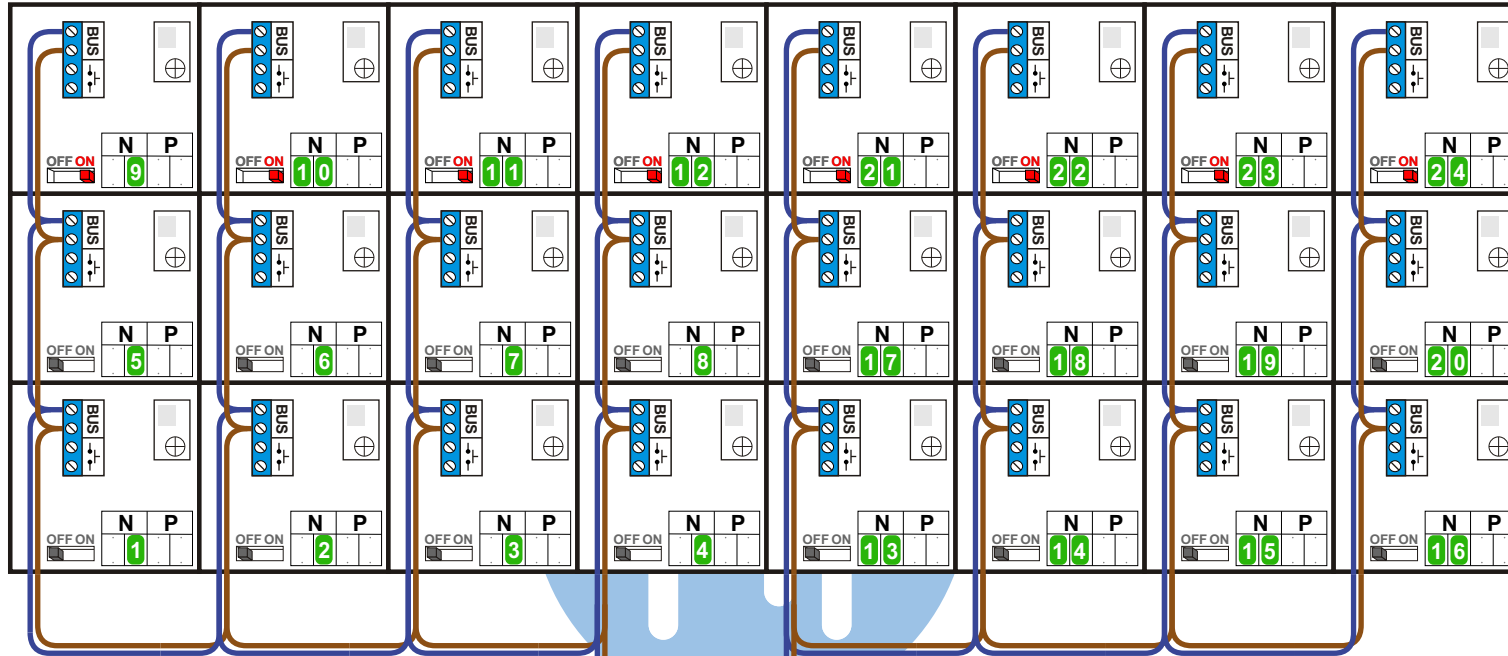

Max. 320 meter systeemkabel tot laatste deurtelefoon

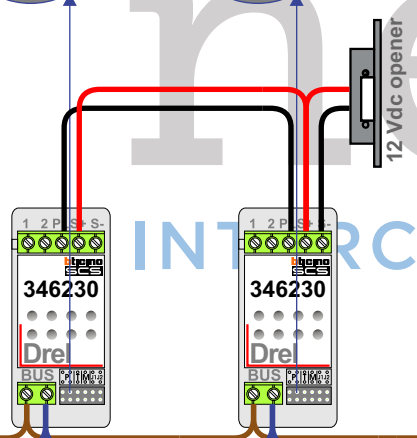
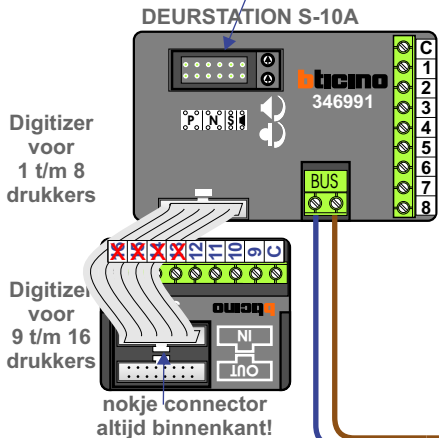
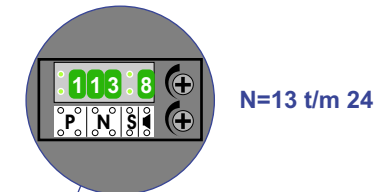

Max. 290 mtr.

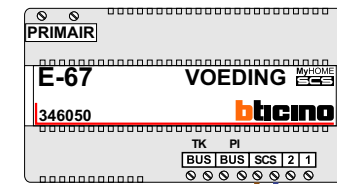
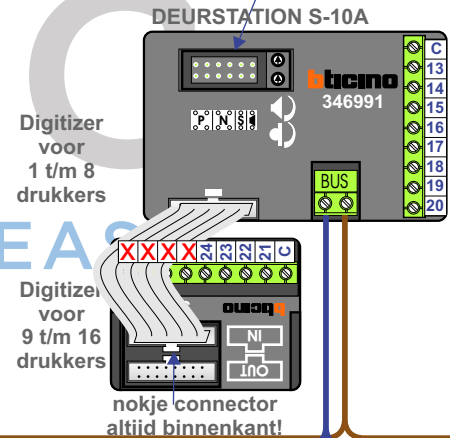

N-waarde	Huisnummer	Switch ON
1	145	
2	147	
3	149	
4	151	
5	153	
6	155	
7	157	
8	159	
9	161	X
10	163	X
11	165	X
12	167	X
13	169	
14	171	
15	173	
16	175	
17	177	
18	179	
19	181	
20	183	
21	185	X
22	187	X
23	189	X
24	191	X

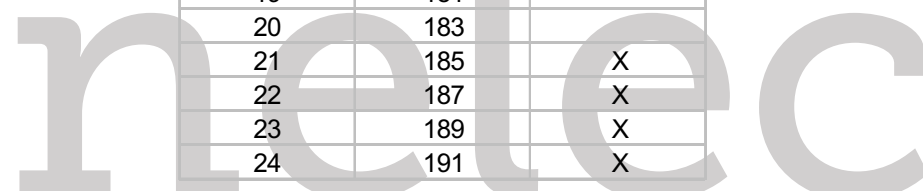
nelec
 INTERCOM MADE EASY

— = systeemkabel
Bij andere getwiste kabel 66% afstand!
Bij ongetwiste kabel max. 50 meter buitenpost naar videofoon.
UTP op aanvraag.

Bij installaties zonder beeld maakt het niet uit hoe je de bus aansluit. De telefoons hoeven niet in serie en eindweerstand zijn niet nodig.

BUS 2-DRAADS



Bij monteren/demonteren spanning eraf en voorkom defecten!

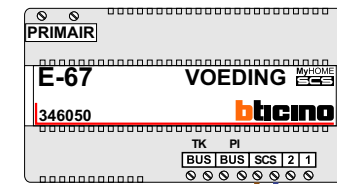
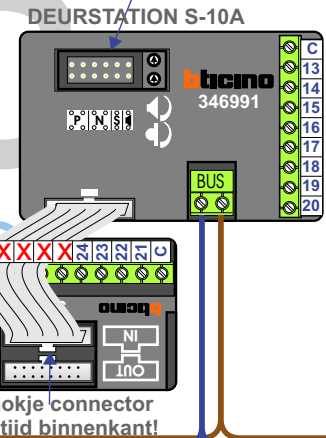
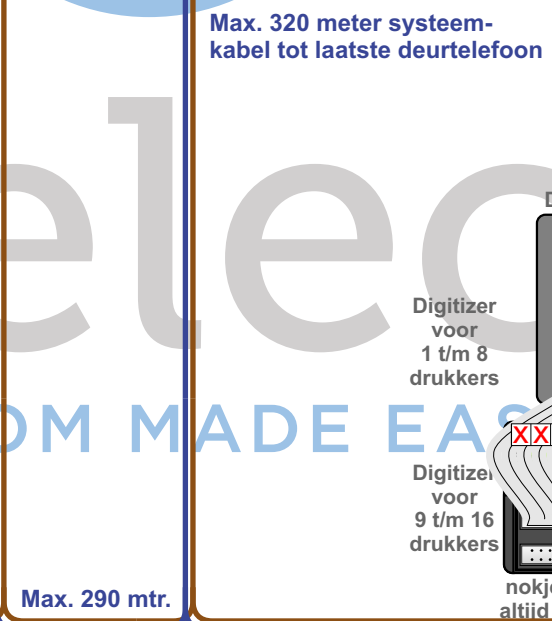
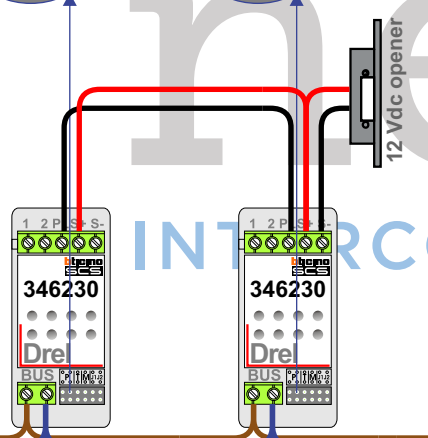
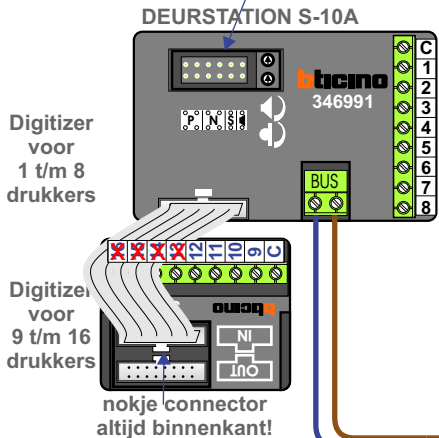
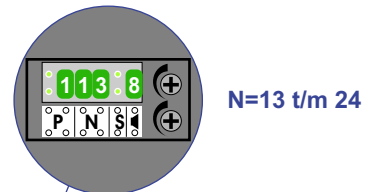
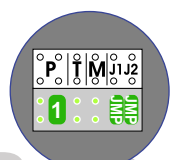
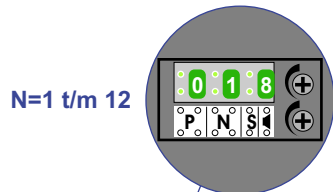
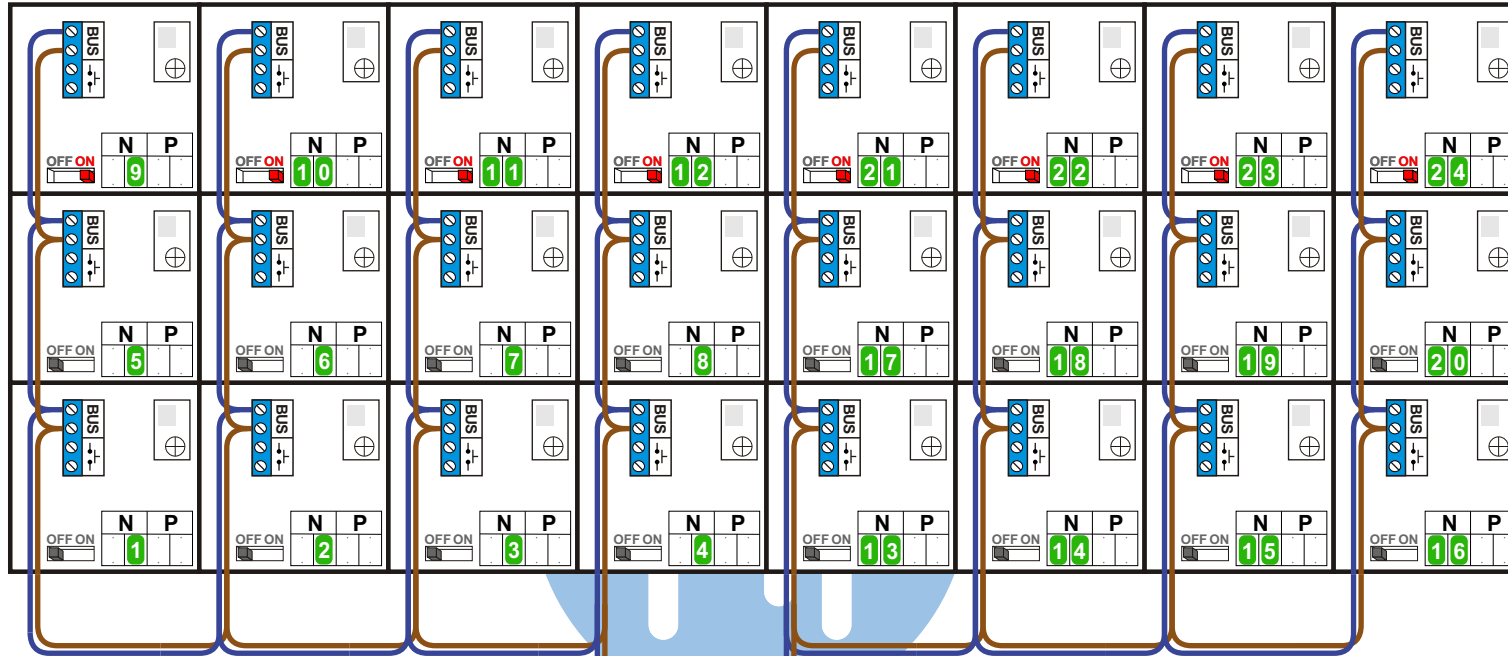

N-waarde	Huisnummer	Switch ON
1	241	
2	243	
3	245	
4	247	
5	249	
6	251	
7	253	
8	255	
9	257	X
10	259	X
11	261	X
12	263	X
13	265	
14	267	
15	269	
16	271	
17	273	
18	275	
19	277	
20	279	
21	281	X
22	283	X
23	285	X
24	287	X

nelec
INTERCOM MADE EASY