



**BUS 2-DRAADS**

Bij monteren/demonteren **spanning eraf** en voorkom defecten!

 = systeemkabel

Bij andere getwiste kabel **66%** afstand!  
Bij ongetwiste kabel **max. 50 meter** buitenpost naar videofoon.  
UTP op aanvraag.



Haal de spanning van het systeem als je een module monteert of demonteert

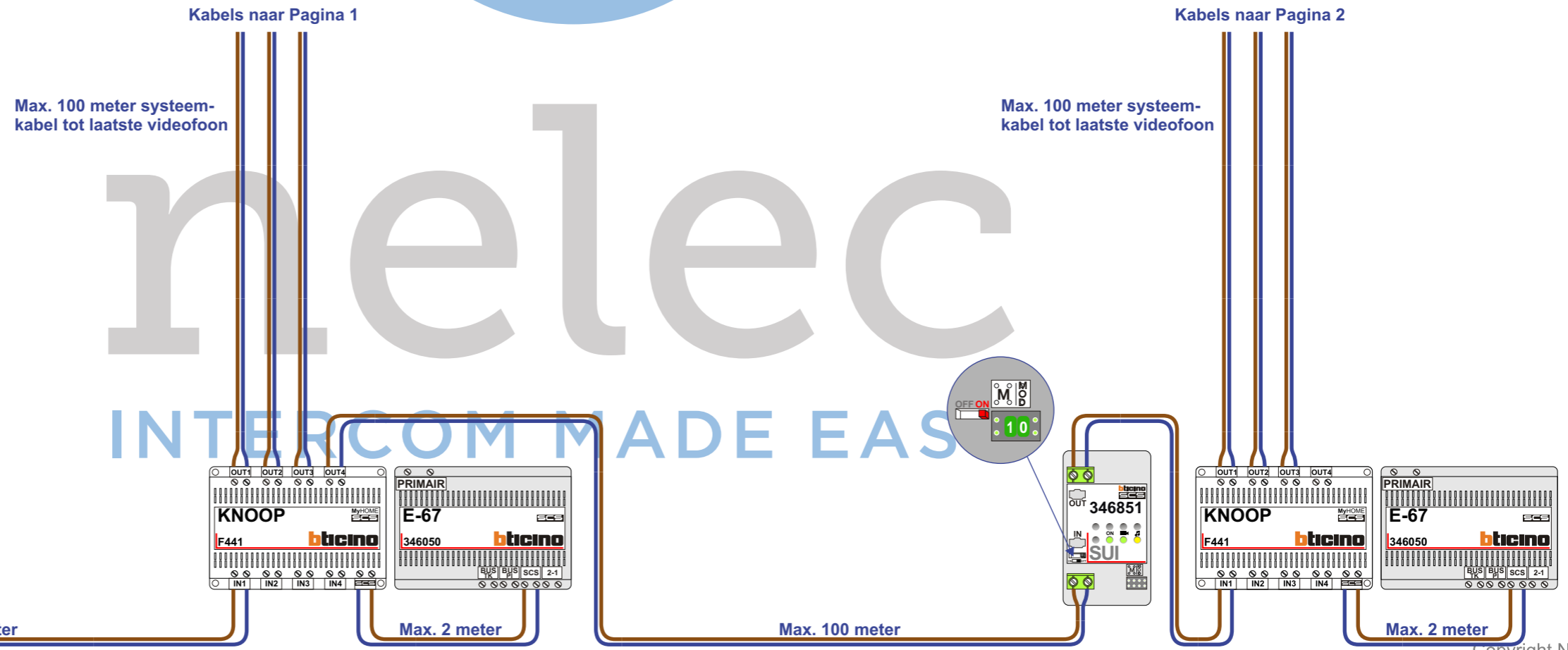
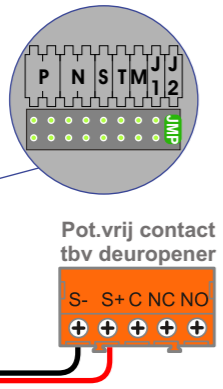
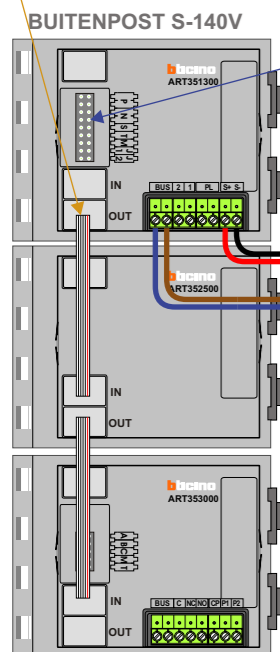

**BUS 2-DRAADS**



Bij monteren/demonteren **spanning eraf** en voorkom defecten!

 = systeemkabel  
Bij andere getwiste kabel **66%** afstand!  
Bij ongetwiste kabel **max. 50 meter** buitenpost naar videofoon.  
UTP op aanvraag.

**VideoVerdeler**



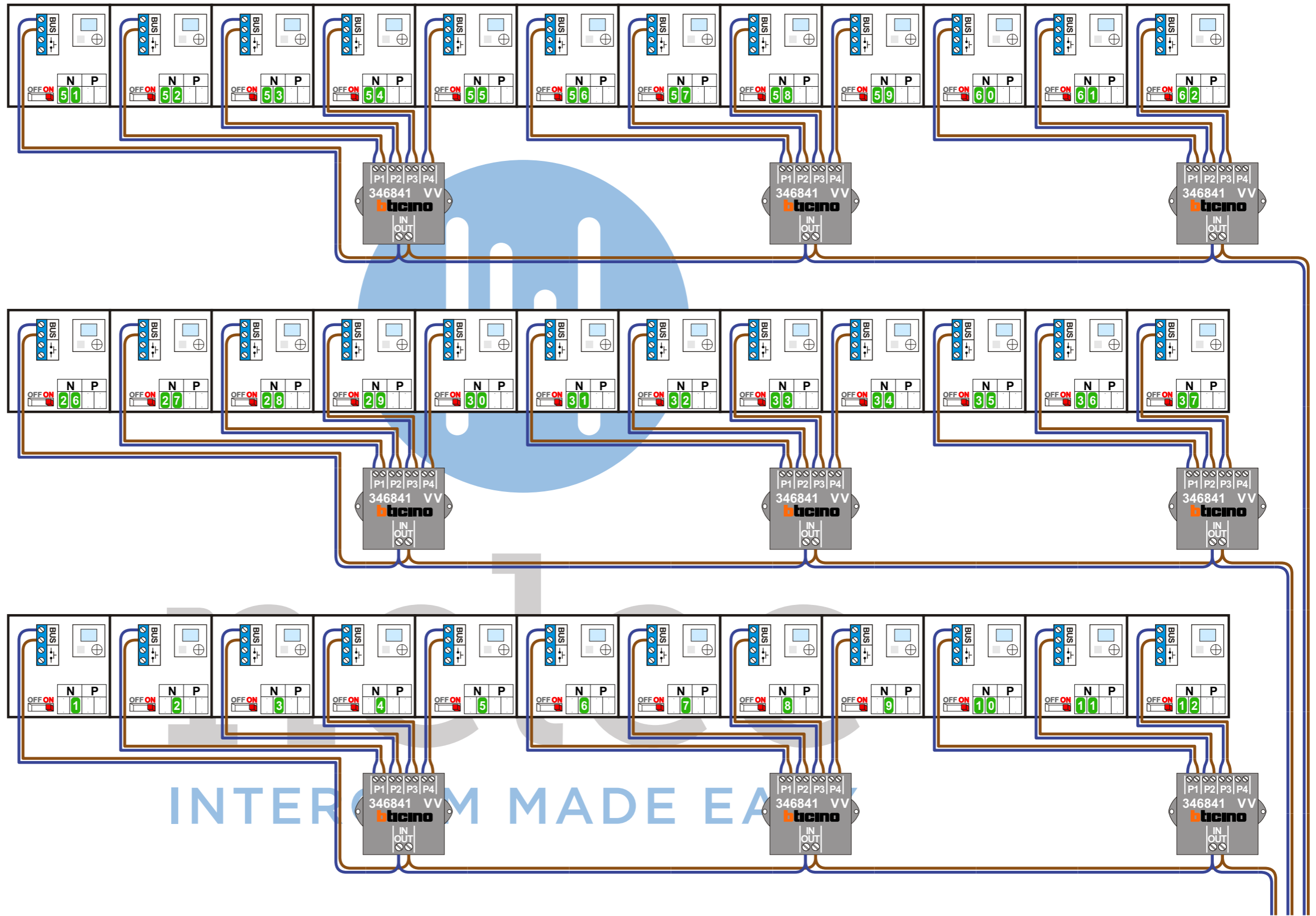

De aders moeten **echt OP** de klemmen doorgelust worden!

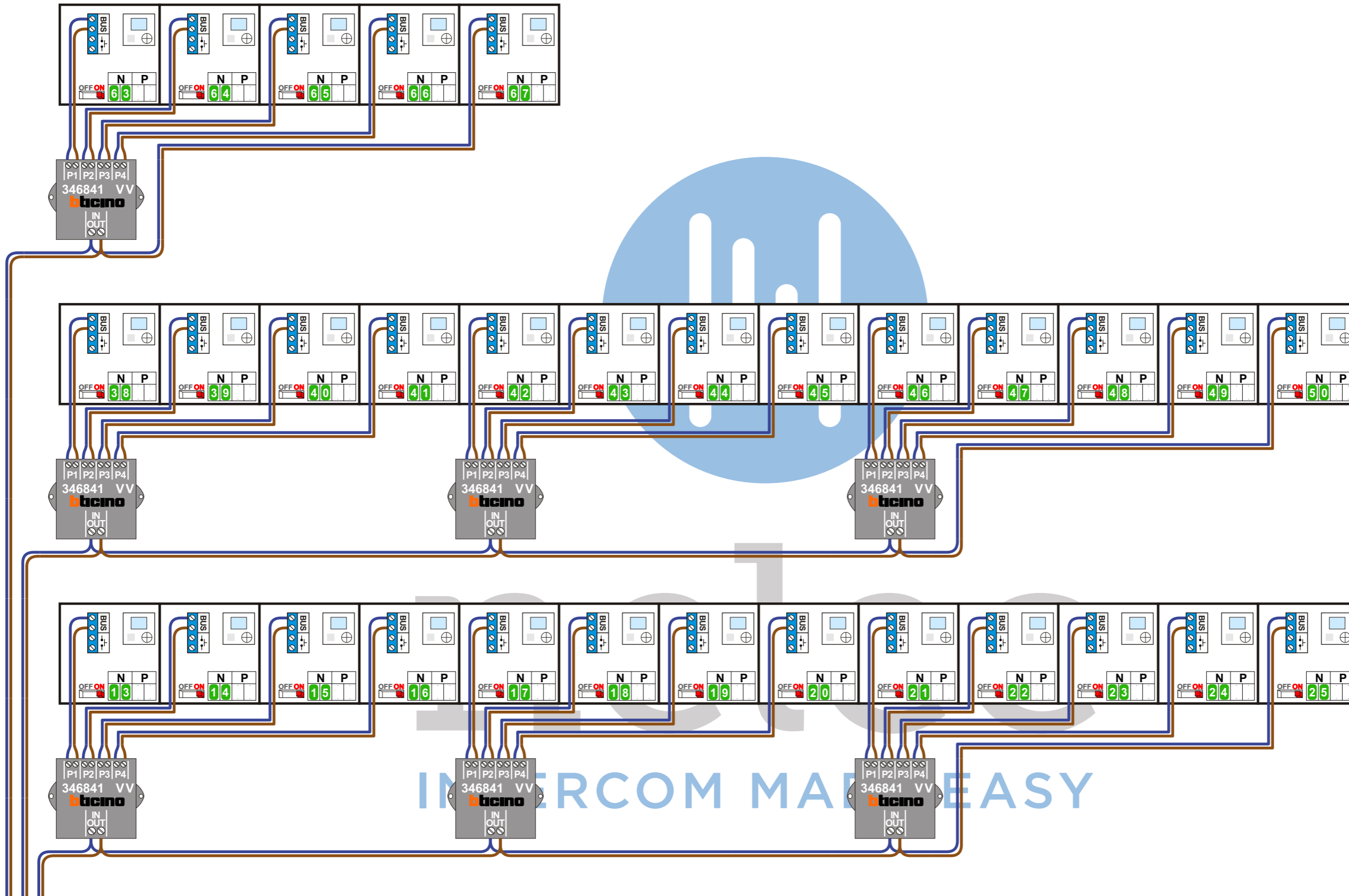

INTERCOM MADE EASY



**BUS 2-DRAADS**

Bij andere getwiste kabel **spanning eraf** en voorkom defecten!

 = systeemkabel  
Bij andere getwiste kabel **66%** afstand!  
Bij ongetwiste kabel **max. 50 meter** buitenpost naar videofoon. UTP op aanvraag.

**VideoVerdeler**



De aders moeten **echt OP de klemmen** doorgelust worden!

INTERCOM MADE EASY



**nelec**  
INTERCOM MADE EASY