

— = systeemkabel
 Bij andere getwiste kabel 66% afstand!
 Bij ongetwiste kabel max. 50 meter buitenpost naar videofoon.
 UTP op aanvraag.

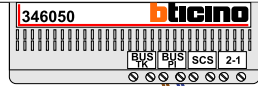

De twee stijgers echt OP de klemmen van E-67 aansluiten!

BUS 2-DRAADS



Bij monteren/demonteren spanning eraf en voorkom defecten!

M-70

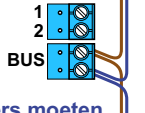

De aders moeten echt OP de connector doorgelust worden!

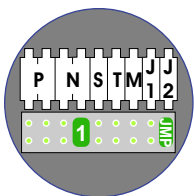
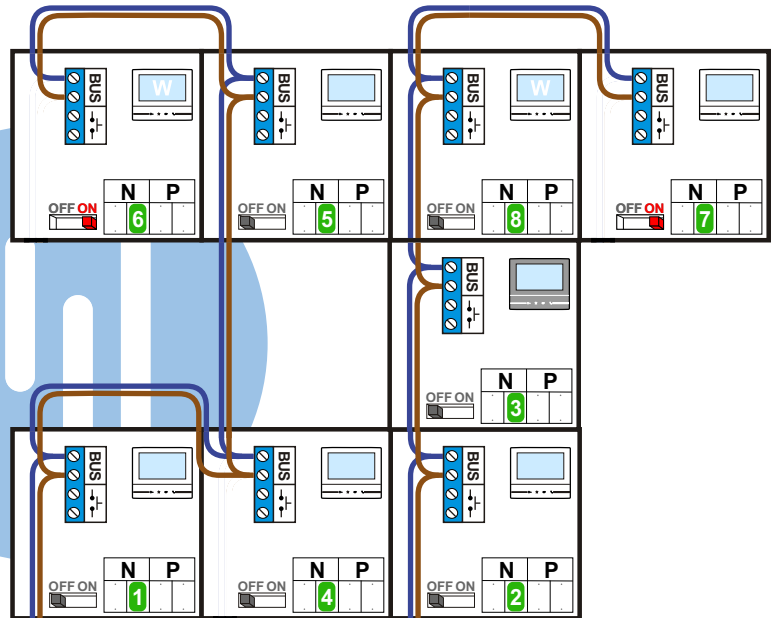

DEURSTATION S-131V

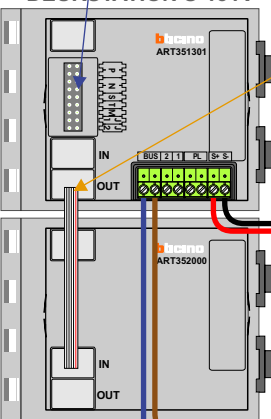

Haal de spanning van het systeem als je een module monteert of demonteert

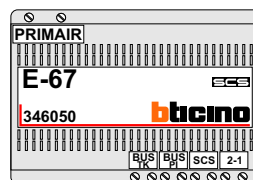

Max. 50 meter

Max. 100 meter systeemkabel tot laatste videofoon

nelec
INTERCOM MADE EASY

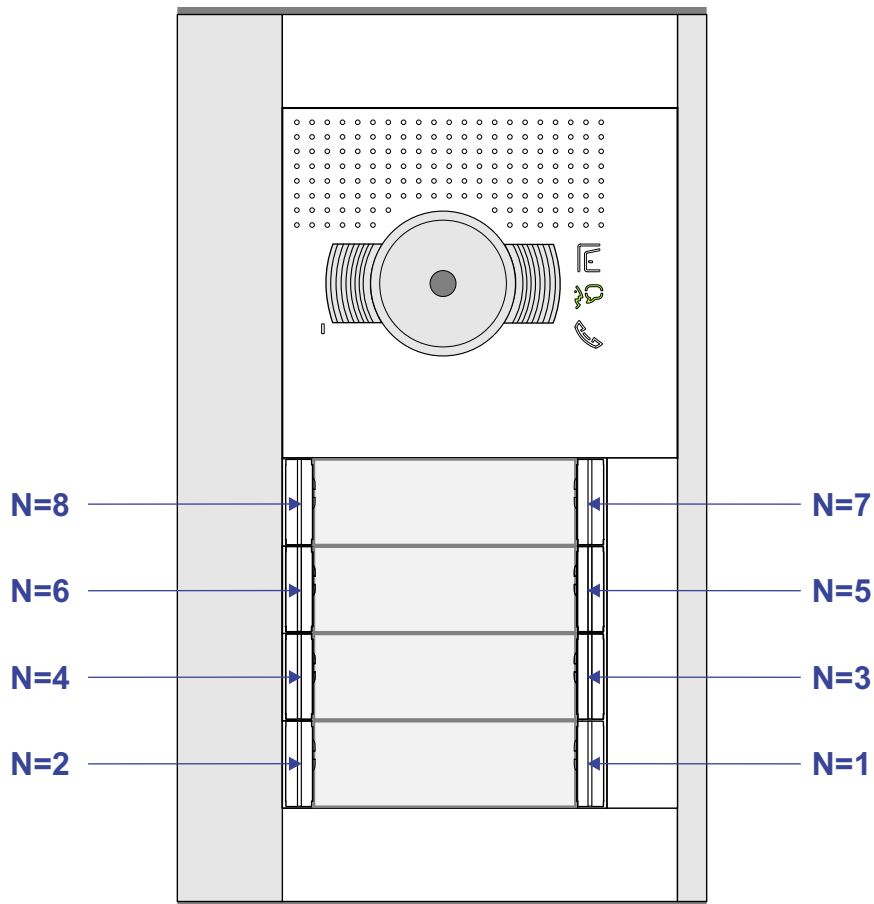

nelec

N-Waarde	Huisnummer	Switch	Toestel
1	34		M-70
2	32		M-70
3	38		M-70 A
4	36		M-70
5	42		M-70
6	40	On	M-70W
7	46	On	M-70
8	44		M-70W