

**TWEEDRAADS BUS**

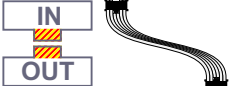

Bij monteren/demonteren spanning eraf voorkomt defecten!

**DD8 digitizer: flatcable**



Connector van flatcable nokje juiste kant op bij aansluiten op DD8

**Digitizers & flatcables**



Niet monteren/demonteren onder spanning Beldrukkers mogen wel

**VideoVerdeler**

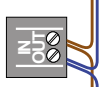

De aders moeten echt OP de klemmen doorgelust worden!

**M-50**

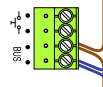

De aders moeten echt OP de connector doorgelust worden!

**— = systeemkabel**

Bij kabel 2 x 1 mm<sup>2</sup>:  
180% afstand!  
Bij kabel 2 x 0,28 mm<sup>2</sup>:  
60% afstand!  
UTP op aanvraag.

Haal de spanning van het systeem als je een digitizer monteert of demonteert

Digitizer voor 1 t/m 8 drukkers

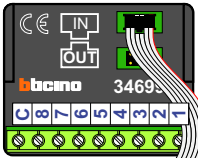

Digitizer voor 9 t/m 16 drukkers

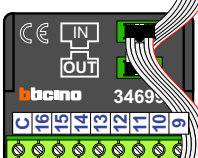

Digitizer voor 17 t/m 24 drukkers

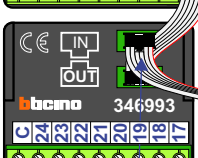

nokjes connectoren wijzen naar elkaar

**DEURSTATION S-130V**

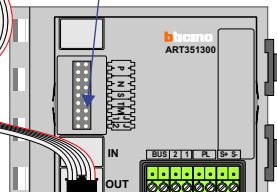

**Hulpvoeding**

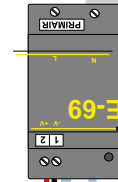

**Pot.vrij contact tbv deuropener**

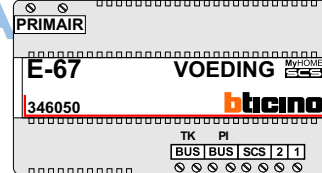

Max. 50 meter

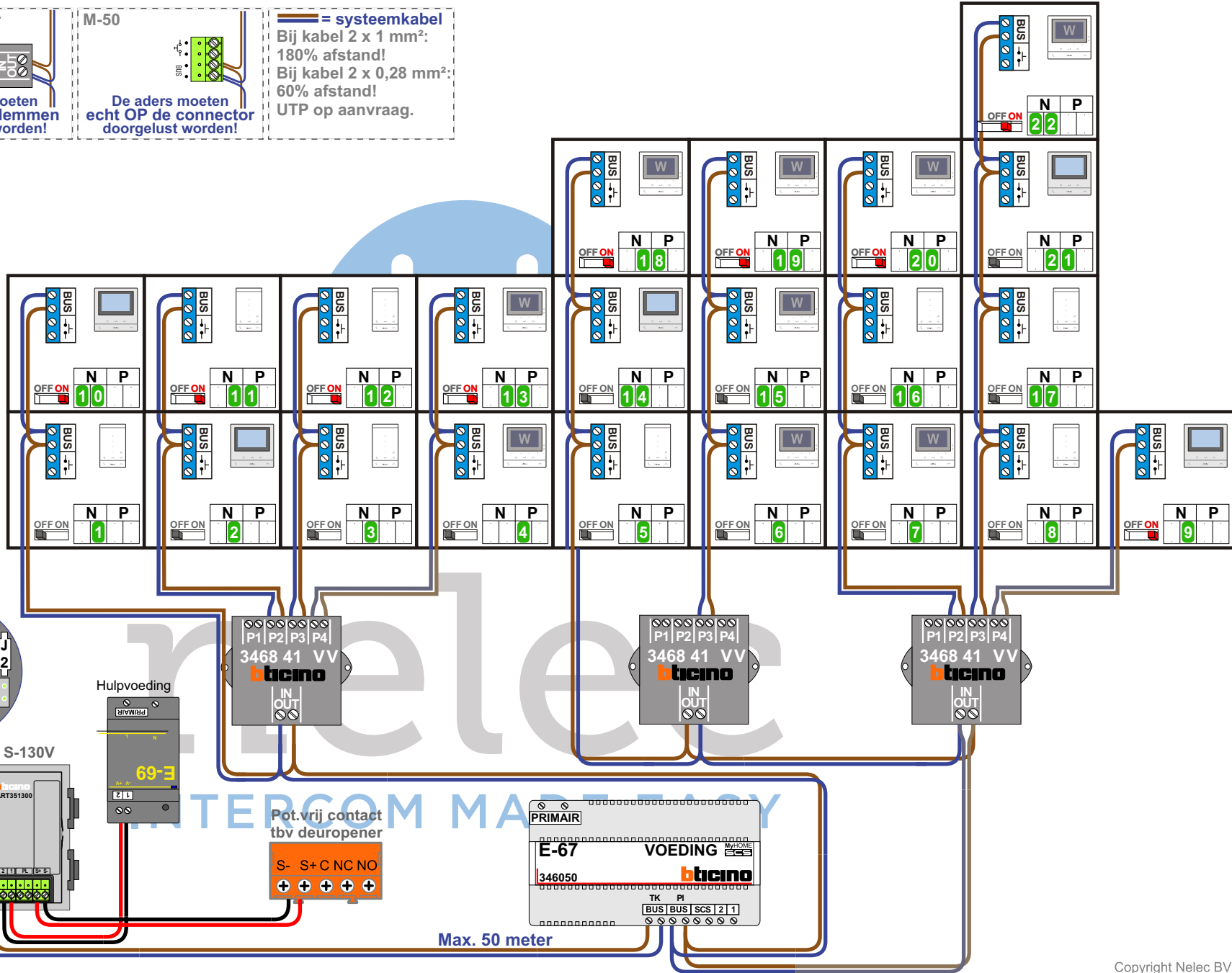

N-Waarde	Huisnummer	Eindweerstand	Toestel
1	1A		T-55
2	1B		M-50B
3	1C		T-55
4	1D		M-50W
5	1E		T-55
6	1F		M-50W
7	1G		M-50W
8	1H		T-55
9	1K	X	M-50B
10	3A	X	M-50B
11	3B	X	T-55
12	3C	X	T-55
13	3D	X	M-50W
14	5A		M-50B
15	5B		M-50W
16	5C		T-55
17	5D		T-55
18	5E	X	M-50W
19	5F	X	M-50W
20	5G	X	M-50W
21	5H		M-50B
22	5K	X	M-50W

**INTERCOM MADE EASY**

TWEEDRAADS BUS



Bij monteren/demonteren spanning eraf voorkomt defecten!

DD8 digitizer: flatcable

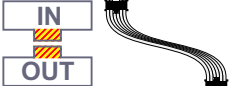

Connector van flatcable nokje juiste kant op bij aansluiten op DD8

Digitizers & flatcables



Niet monteren/demonteren onder spanning  
Beldrukkers mogen wel

N-Waarde	Huisnummer	Eindweerstand	Toestel
1	5N	X	M-50B
2	5P	X	M-50B
3	5Q	X	M-50B
4	5R	X	T-55

= systeemkabel  
Bij kabel 2 x 1 mm<sup>2</sup>:  
180% afstand!  
Bij kabel 2 x 0,28 mm<sup>2</sup>:  
60% afstand!  
UTP op aanvraag.

VideoVerdeler



De aders moeten echt OP de klemmen doorgelust worden!

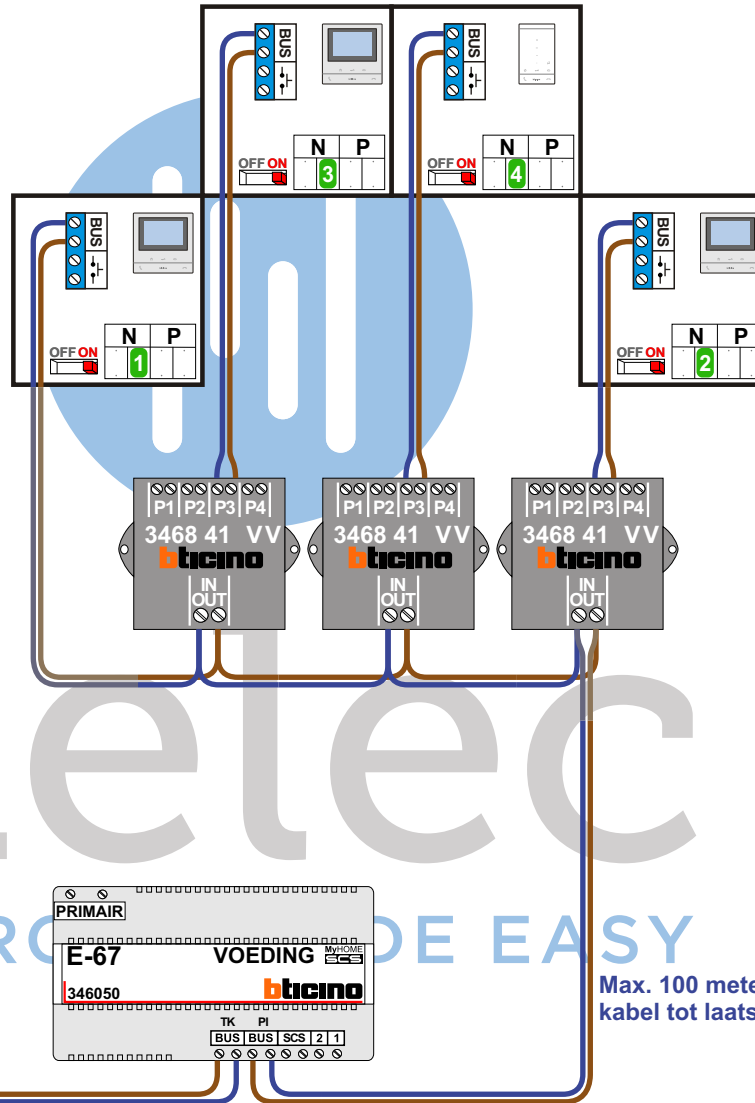

Pot.vrij contact  
tbv deuropener

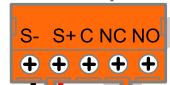

Haal de spanning van het systeem als je de digitizer monteert of demonteert

Digitizer voor 1 t/m 8 drukkers

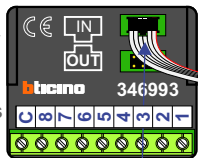

DEURSTATION S-130V

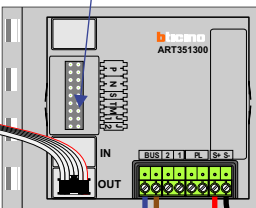

nokjes connectoren wijzen naar elkaar

Max. 50 meter

Max. 100 meter systeemkabel tot laatste videofoon

N-Waarde	Huisnummer	Eindweerstand	Toestel
1	5N	X	M-50B
2	5P	X	M-50B
3	5Q	X	M-50B
4	5R	X	T-55



nelec  
INTERCOM MADE EASY