

— = systeemkabel
Bij andere getwiste kabel 66% afstand!
Bij ongetwiste kabel max. 50 meter buitenpost naar videofoon.
UTP op aanvraag.

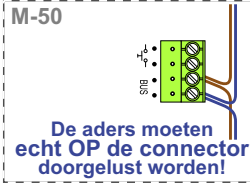

TWEEDRAADS BUS



Bij monteren/demonteren spanning eraf voorkomt defecten!

N-Waarde	Huisnummer	Switch-ON	Videofoon
1	86		M-50B
2	87		T-55
3	88		M-50B
4	89		M-50B
5	90		M-50B
6	91		M-50B
7	92		M-50W ifi
8	93	X	M-50B
9	94		M-50W ifi
10	95	X	M-50B
11	96	X	M-50W ifi

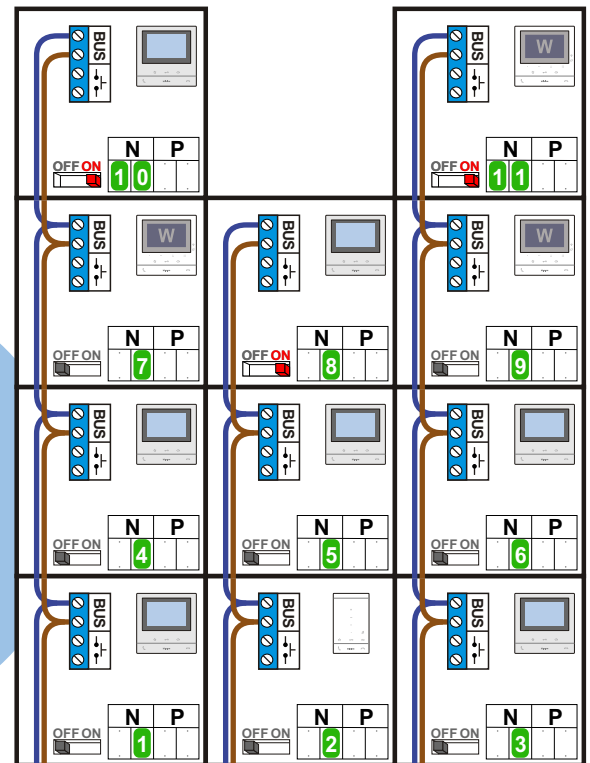

nelec

INTERCOM MADE EASY

Haal de spanning van het systeem als je een digitizer monteert of demonteert

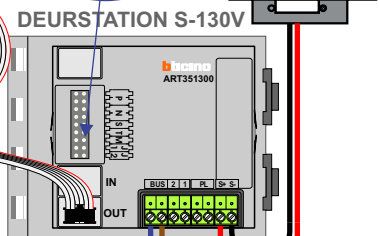
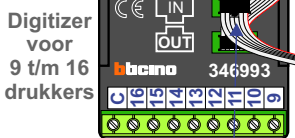
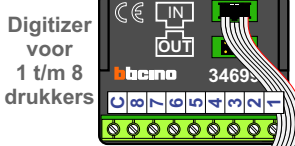
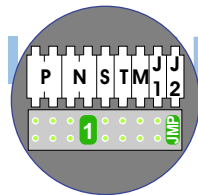

nokjes connectoren wijzen naar elkaar

Max. 50 meter

Max. 100 meter systeemkabel tot laatste videofoon

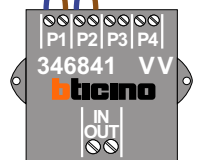
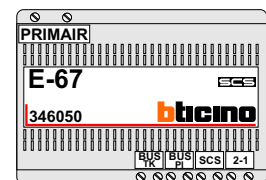

— = systeemkabel
Bij andere getwiste kabel 66% afstand!
Bij ongetwiste kabel max. 50 meter buitenpost naar videofoon.
UTP op aanvraag.

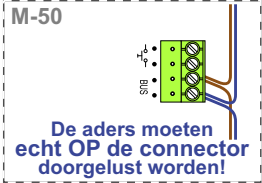

TWEEDRAADS BUS

Bij monteren/demonteren spanning eraf voorkomt defecten!

N-Waarde	Huisnummer	Switch-ON	Videofoon
1	97		M-50B
2	98		M-50B
3	99		T-55
4	100		M-50B
5	101		M-50B
6	102		M-50W ifi
7	103		M-50B
8	104	X	M-50B
9	105		M-50B
10	106	X	M-50W ifi
11	107	X	M-50B

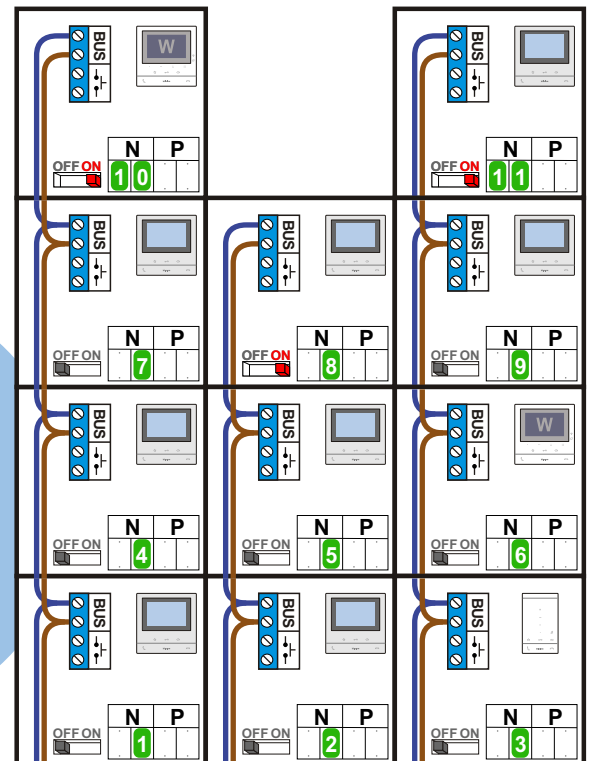

nelec

INTERCOM MADE EASY

Haal de spanning van het systeem als je een digitizer monteert of demonteert

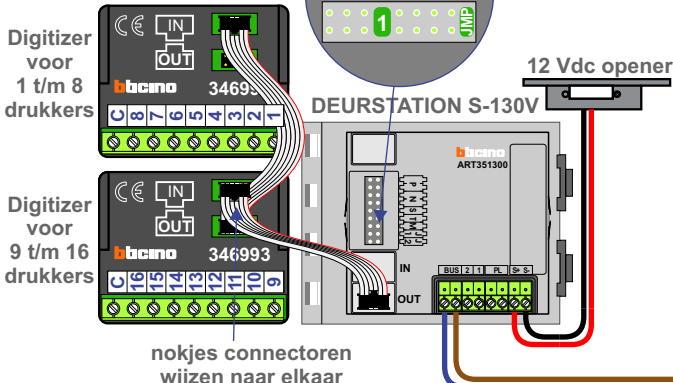
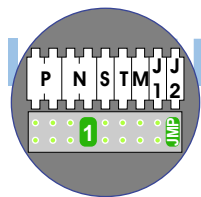

Max. 100 meter systeemkabel tot laatste videofoon

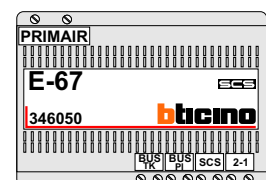

Max. 50 meter