

— = systeemkabel
 Bij andere getwiste kabel 66% afstand!
 Bij ongetwiste kabel max. 50 meter buitenpost naar videofoon.
 UTP op aanvraag.

BUS 2-DRAADS



Bij monteren/demonteren spanning eraf en voorkom defecten!

M-50b



De aders moeten echt **OP** de connector doorgelust worden!

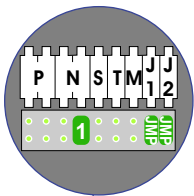
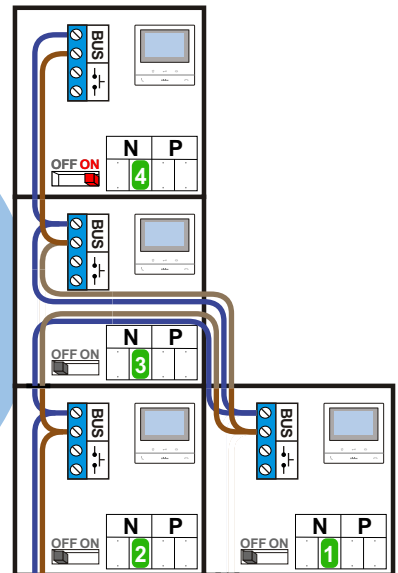

Haal de spanning van het systeem als je een module monteert of demonteert

nelec
INTERCOM MADE EASY

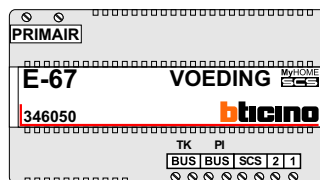
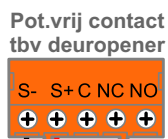
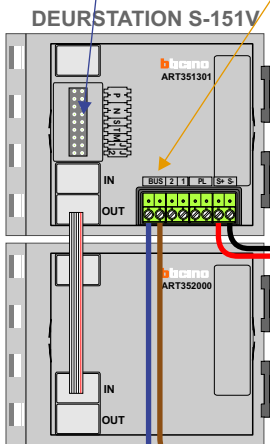

Max. 50 meter

Max. 100 meter systeemkabel tot laatste videofoon



nelec
INTERCOM MADE EASY

— = systeemkabel
Bij andere getwiste kabel 66% afstand!
Bij ongetwiste kabel max. 50 meter buitenpost naar videofoon.
UTP op aanvraag.

BUS 2-DRAADS



Bij monteren/demonteren spanning eraf en voorkom defecten!

M-50b



De aders moeten echt **OP** de connector doorgelust worden!

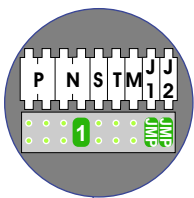
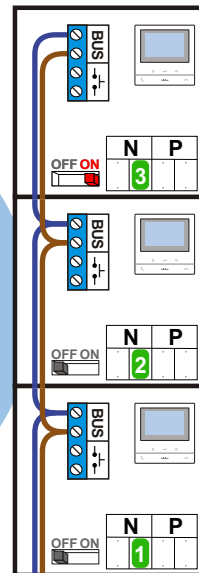

Haal de spanning van het systeem als je een module monteert of demonteert

nelec
INTERCOM MADE EASY

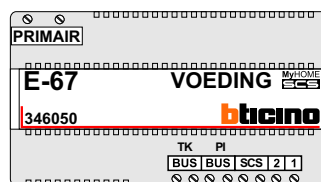
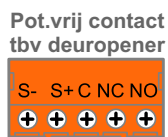
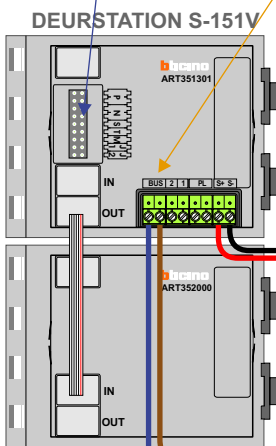

Max. 100 meter systeemkabel tot laatste videofoon

Max. 50 meter

 = systeemkabel

Bij andere getwiste kabel 66% afstand!
Bij ongetwiste kabel max. 50 meter buitenpost naar videofoon.
UTP op aanvraag.

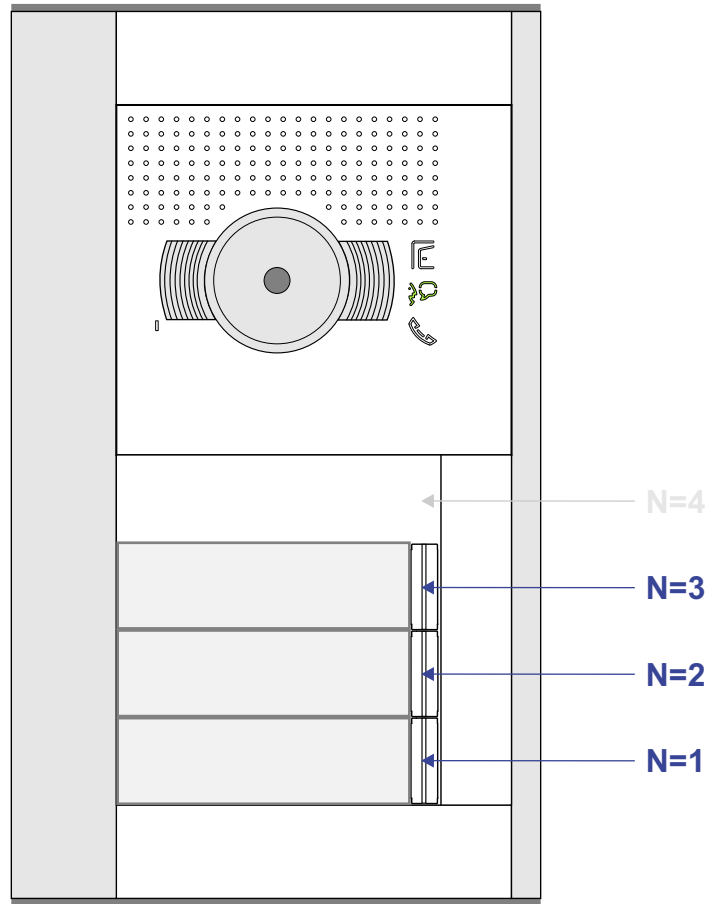

nelec
INTERCOM MADE EASY