

— = systeemkabel
Bij andere getwiste kabel 66% afstand!
Bij ongetwiste kabel max. 50 meter buitenpost naar videofoon.
UTP op aanvraag.

N-Waarde	Huisnummer	Switch-ON
1	50	X
2	52	X
3	54	X
4	56	X

BUS 2-DRAADS

Bij monteren/demonteren spanning eraf en voorkom defecten!

VideoVerdeler

De aders moeten echt **OP** de klemmen doorgelust worden!

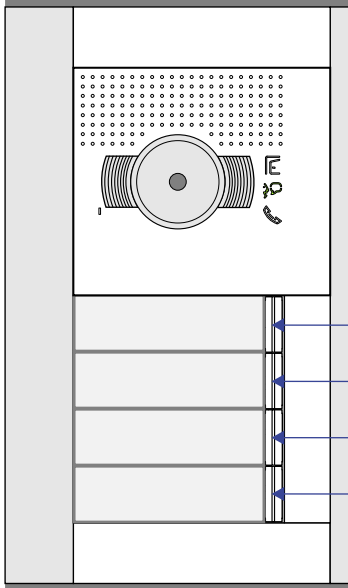

nelec

INTERCOM MADE EASY

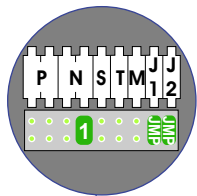

Haal de spanning van het systeem als je een module monteert of demonteert

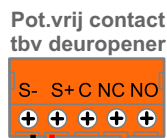
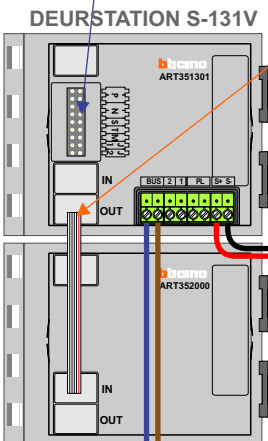

Max. 50 meter

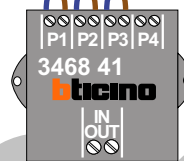
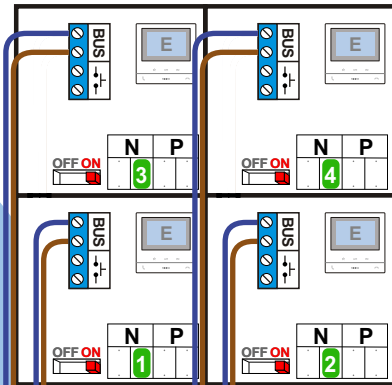
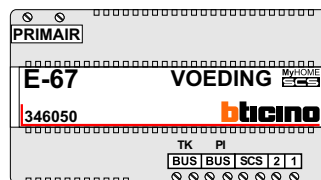

Max. 100 meter systeemkabel tot laatste videofoon