

— — — = systeemkabel
 Bij andere getwiste kabel 66% afstand!
 Bij ongetwiste kabel max. 50 meter buitenpost naar videofoon.
 UTP op aanvraag.

BUS 2-DRAADS

Bij monteren/demonteren spanning eraf en voorkom defecten!

M-50b

De aders moeten echt **OP** de connector doorgelust worden!



nelec
INTERCOM MADE EASY

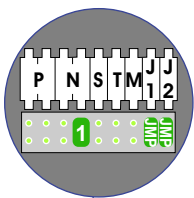

Haal de spanning van het systeem als je een module monteert of demonteert

DEURSTATION S-131V

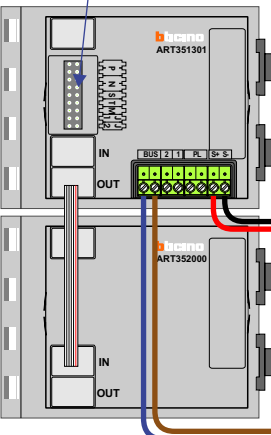

12 Vdc opener

12 Vdc opener

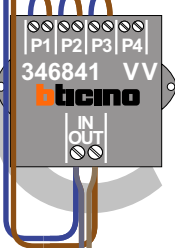
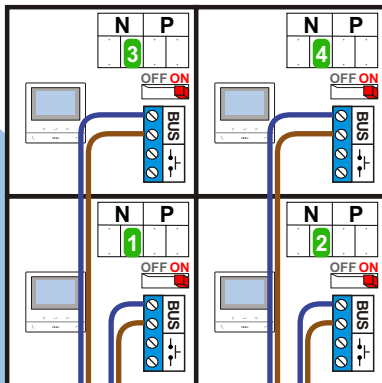
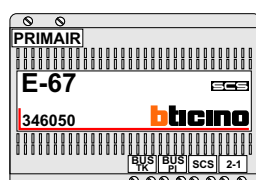
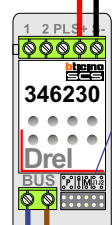
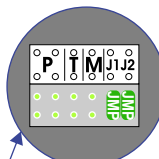

Max. 50 meter

Max. 100 meter systeemkabel tot laatste videofoon

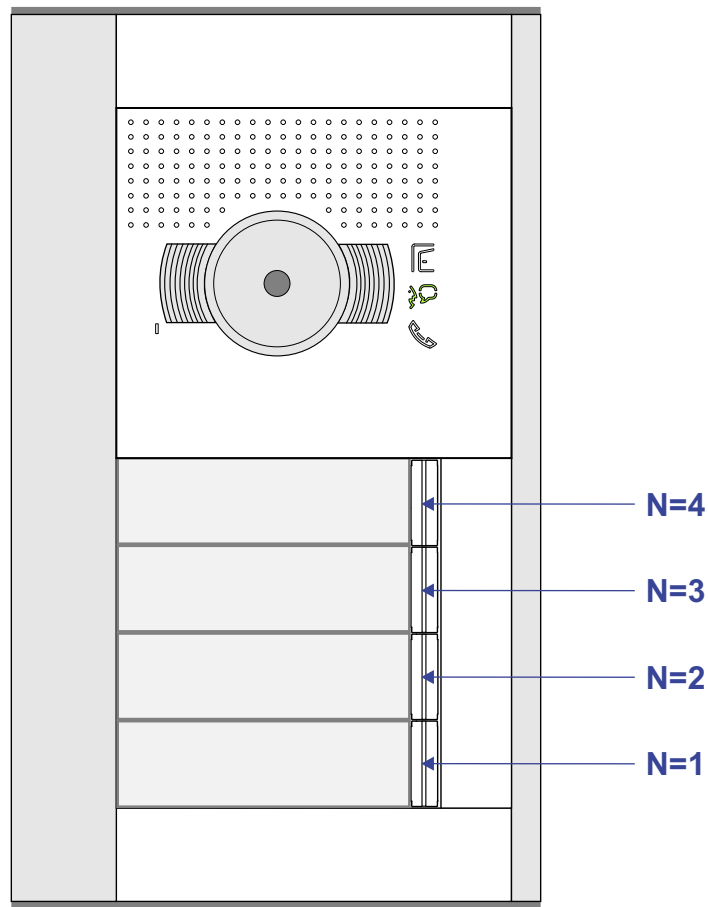

nelec
INTERCOM MADE EASY