

**BUS 2-DRAADS**



Bij monteren/demonteren spanning eraf en voorkom defecten!

**— = systeemkabel**

Bij kabel 2 x 1 mm<sup>2</sup>:  
180% afstand!  
Bij kabel 2 x 0,28 mm<sup>2</sup>:  
60% afstand!  
UTP op aanvraag.

**VideoVerdeler**



De aders moeten echt OP de klemmen doorgelust worden!

Haal de spanning van het systeem als je een digitizer monteert of demonteert

Digitizer voor 1 t/m 8 drukkers

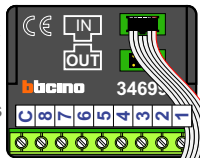

Digitizer voor 9 t/m 16 drukkers

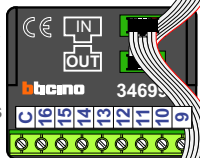

Digitizer voor 17 t/m 24 drukkers

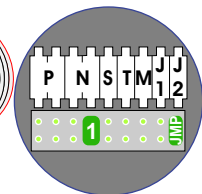
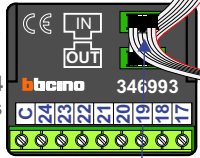

DEURSTATION S-130V

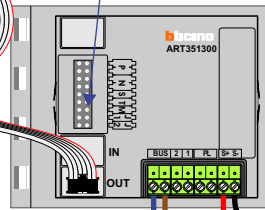

Pot.vrij contact tbv deur opener

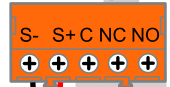

nokjes connectoren wijzen naar elkaar

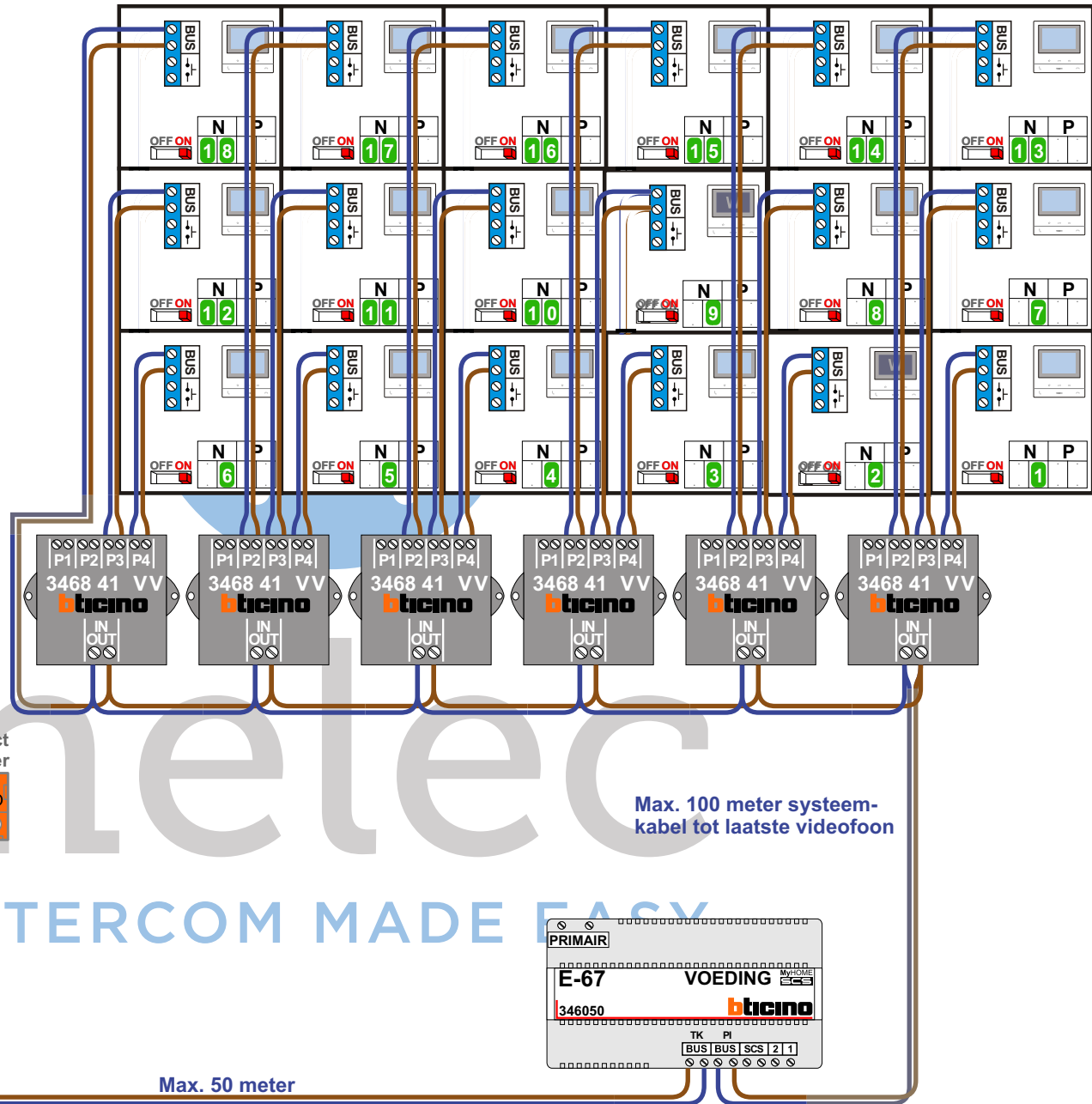

Max. 100 meter systeemkabel tot laatste videofoon

Max. 50 meter

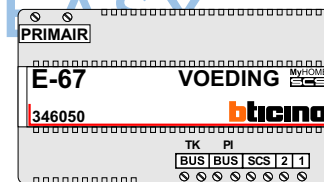

N-Waarde	Huisnummer	Switch-ON	Videofoon
1	107A	X	M-50B
2	107B	X	M-50Wifi
3	107C	X	M-50B
4	107D	X	M-50B
5	107E	X	M-50B
6	107F	X	M-50B
7	109A	X	M-50B
8	109B	X	M-50B
9	109C	X	M-50Wifi
10	109D	X	M-50B
11	109E	X	M-50B
12	109F	X	M-50B
13	111A	X	M-50B
14	111B	X	M-50B
15	111C	X	M-50B
16	111D	X	M-50B
17	111E	X	M-50B
18	111F	X	M-50B

nelec  
INTERCOM MADE EASY