

— = systeemkabel
 Bij kabel 2 x 1 mm²:
 180% afstand!
 Bij kabel 2 x 0,28 mm²:
 60% afstand!
 UTP op aanvraag.

VideoVerdeler



De aders moeten echt OP de klemmen doorgelust worden!

BUS 2-DRAADS



Bij monteren/demonteren spanning eraf en voorkom defecten!



De twee stijgers echt OP de klemmen van E-67 aansluiten!

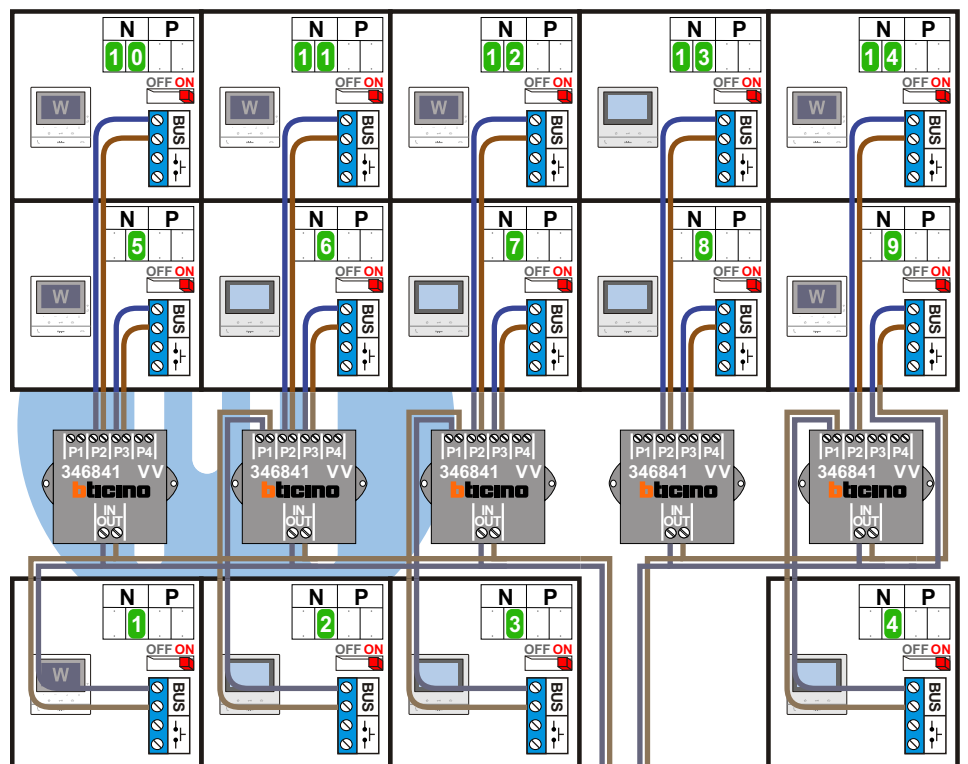

nelec

INTERCOM MADE EASY

Haal de spanning van het systeem als je een digitizer monteert of demonteert

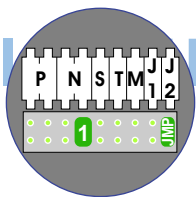

Pot.vrij contact tbv deurpenner



DEURSTATION S-130V

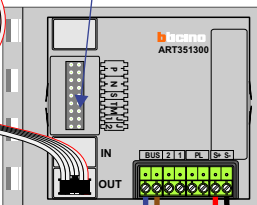

Digitizer voor 1 t/m 8 drukkers

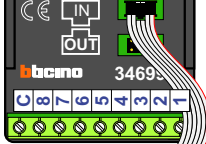

Digitizer voor 9 t/m 16 drukkers

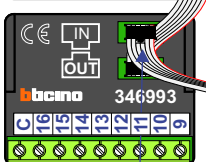

nokjes connectoren wijzen naar elkaar

Max. 50 meter

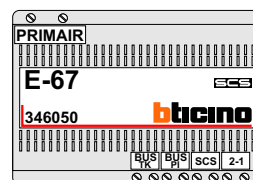

Max. 100 meter systeemkabel tot laatste videofoon

N-waarde	Huisnummer	Eindweerstand	Videfoon
1	2	X	M-50WiFi
2	4	X	M-50b
3	6	X	M-50b
4	8	X	M-50b
5	10	X	M-50WiFi
6	12	X	M-50b
7	14	X	M-50b
8	16	X	M-50b
9	18	X	M-50WiFi
10	20	X	M-50WiFi
11	22	X	M-50WiFi
12	24	X	M-50WiFi
13	26	X	M-50b
14	28	X	M-50WiFi

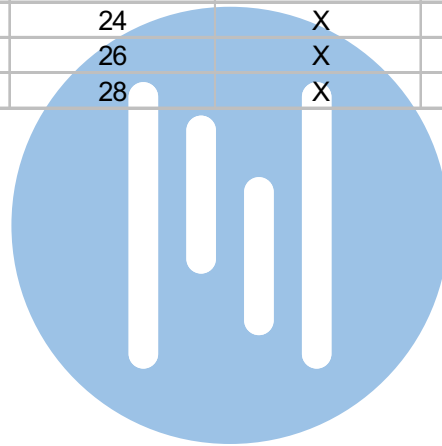

nelec
INTERCOM MADE EASY