

— = systeemkabel
 Bij kabel 2 x 1 mm²:
 180% afstand!
 Bij kabel 2 x 0,28 mm²:
 60% afstand!
 UTP op aanvraag.

BUS 2-DRAADS



Bij monteren/demonteren
 spanning eraf
 en voorkom defecten!

VideoVerdeler



De aders moeten
 echt **OP** de klemmen
 doorgelust worden!

M-50

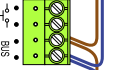

De aders moeten
 echt **OP** de connector
 doorgelust worden!

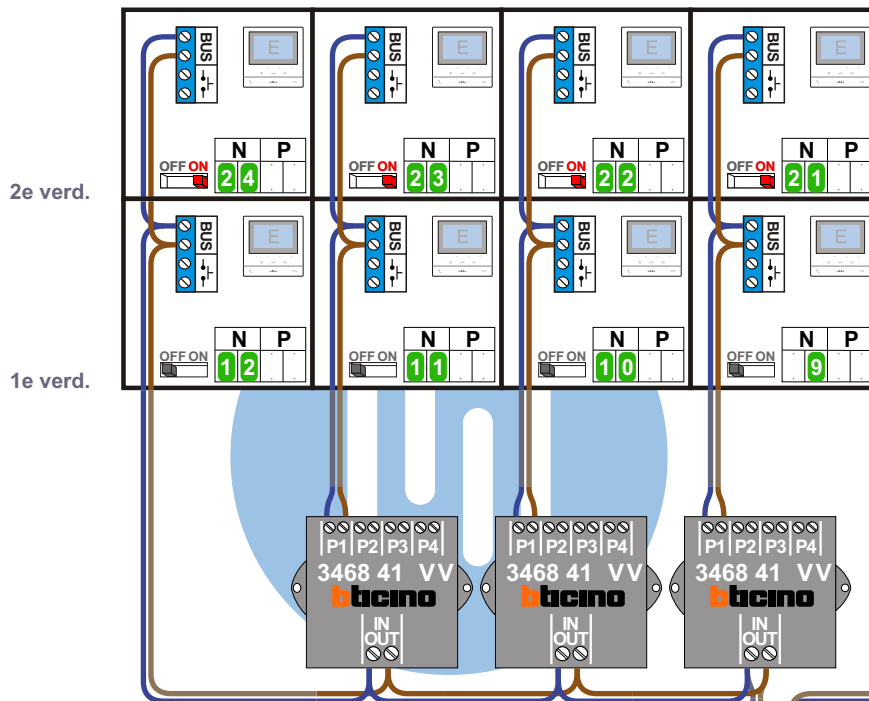

Haal de spanning van het
 systeem als je een digitizer
 monteert of demonteert

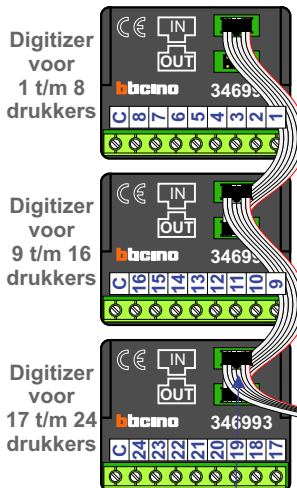

nokjes connectoren
 wijzen naar elkaar

Max. 50 meter

Max. 100 meter systeem-
 kabel tot laatste videofoon

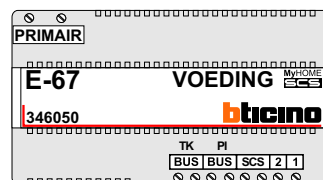

VideoVerdeler



De aders moeten echt OP de klemmen doorgelust worden!

M-50

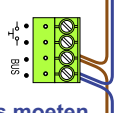

De aders moeten echt OP de connector doorgelust worden!

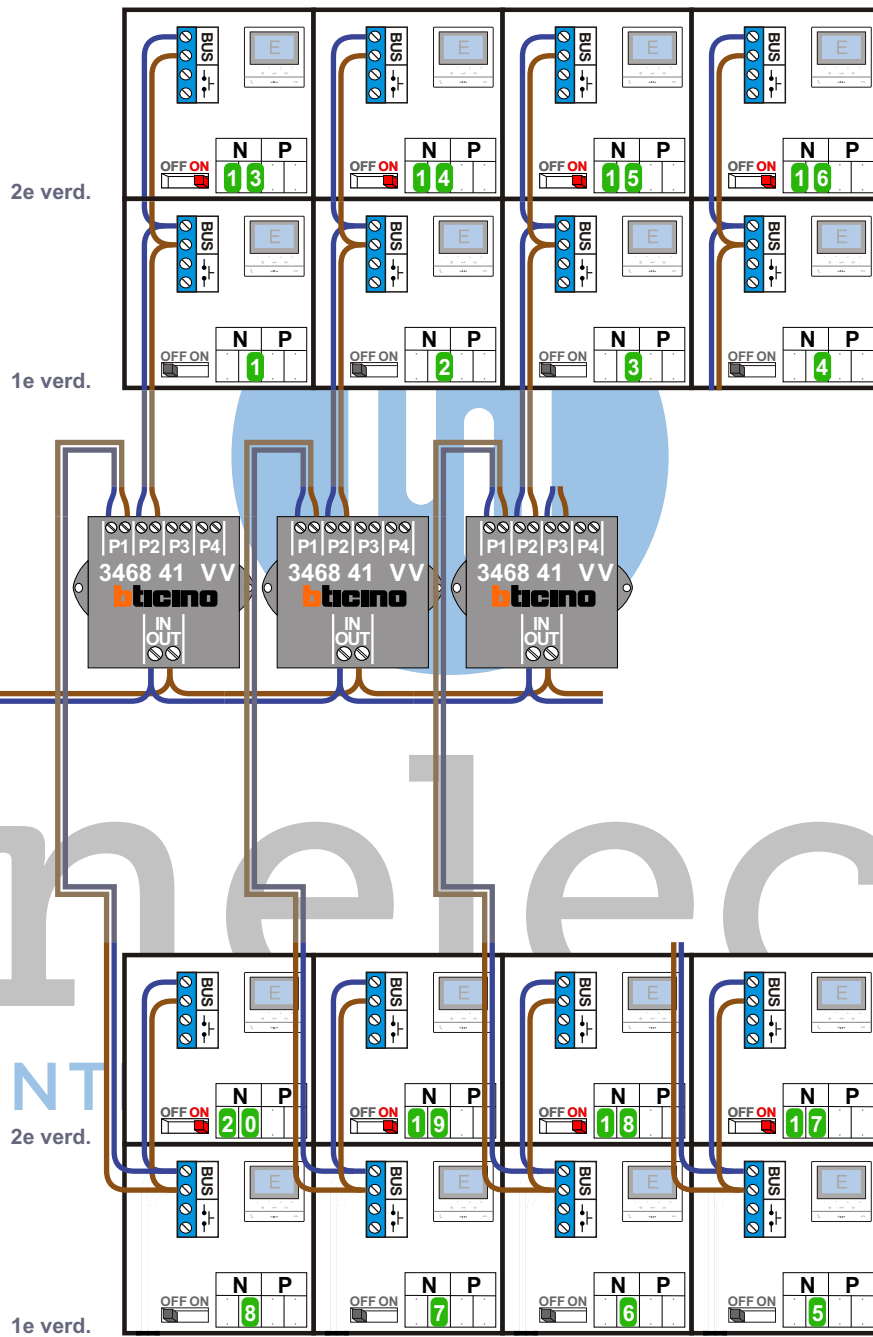

| N-waarde | Huisnummer | Eindweerstand |
|----------|------------|---------------|
| 1 | 101 | |
| 2 | 102 | |
| 3 | 103 | |
| 4 | 104 | |
| 5 | 105 | |
| 6 | 106 | |
| 7 | 107 | |
| 8 | 108 | |
| 9 | 109 | |
| 10 | 110 | |
| 11 | 111 | |
| 12 | 112 | |
| 13 | 201 | X |
| 14 | 202 | X |
| 15 | 203 | X |
| 16 | 204 | X |
| 17 | 205 | X |
| 18 | 206 | X |
| 19 | 207 | X |
| 20 | 208 | X |
| 21 | 209 | X |
| 22 | 210 | X |
| 23 | 211 | X |
| 24 | 212 | X |



nelec
INTERCOM MADE EASY