

TWEEDRAADS BUS

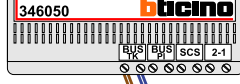

Bij monteren/demonteren spanning eraf voorkomt defecten!

— = systeemkabel
Bij andere getwiste kabel 66% afstand!
Bij ongetwiste kabel max. 50 meter buitenpost naar videofoon.
UTP op aanvraag.



De twee buitenposten echt OP de klemmen van E-67 aansluiten!

VideoVerdeler



De aders moeten echt OP de klemmen doorgelust worden!

M-50



De aders moeten echt OP de connector doorgelust worden!

N-Waarde	Huisnummer	Switch-ON	Videofoon
1	1		M-50B
2	3		M-50W ifi
3	5		M-50B
4	7		M-50B
5	9		M-50W ifi
6	11		M-50W ifi
7	13		M-50W ifi
8	15		M-50W ifi
9	17		M-50W ifi
10	19		M-50W ifi
11	21		M-50W ifi
12	23	X	M-50W ifi
13	25		M-50B
14	27		M-50B
15	29	X	M-50W ifi
16	31	X	M-50W ifi

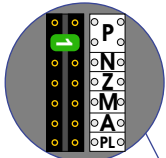
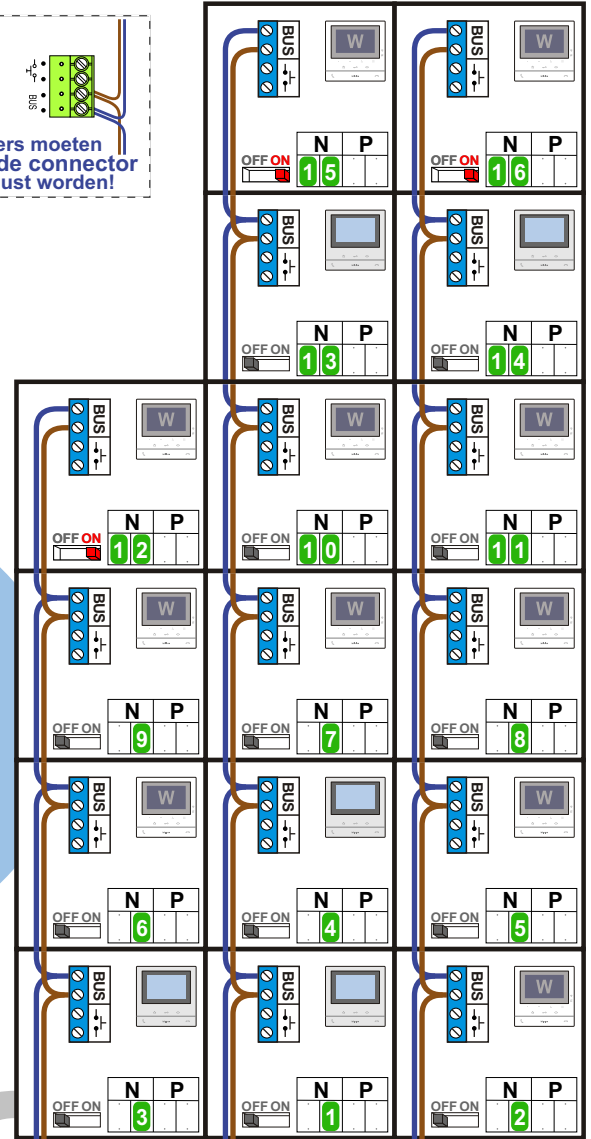

max. 3 meter coax
kern coax
mantel coax

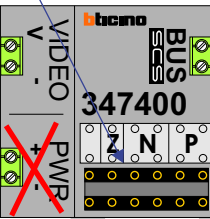

Camera een eigen voeding geven!

Max. 50 meter

Haal de spanning van het systeem als je een digitizer monteert of demonteert

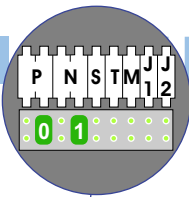

Pot.vrij contact tbv deuropener



Digitizer voor 1 t/m 8 drukkers

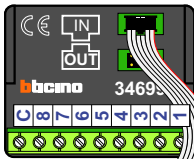

DEURSTATION S-130V

Digitizer voor 9 t/m 16 drukkers

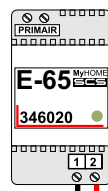
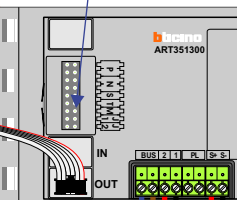
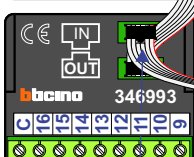

nokjes connectoren wijzen naar elkaar

gepolariiseerd

Max. 50 meter

Max. 100 meter systeemkabel tot laatste videofoon

