

— = systeemkabel
 Bij andere getwiste kabel 66% afstand!
 Bij ongetwiste kabel max. 50 meter buitenpost naar videofoon.
 UTP op aanvraag.

TWEEDRAADS BUS



Bij monteren/demonteren spanning eraf voorkomt defecten!



De twee buitenposten echt OP de klemmen van E-67 aansluiten!

M-50

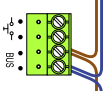

De aders moeten echt OP de connector doorgelust worden!

VideoVerdeler



De aders moeten echt OP de klemmen doorgelust worden!

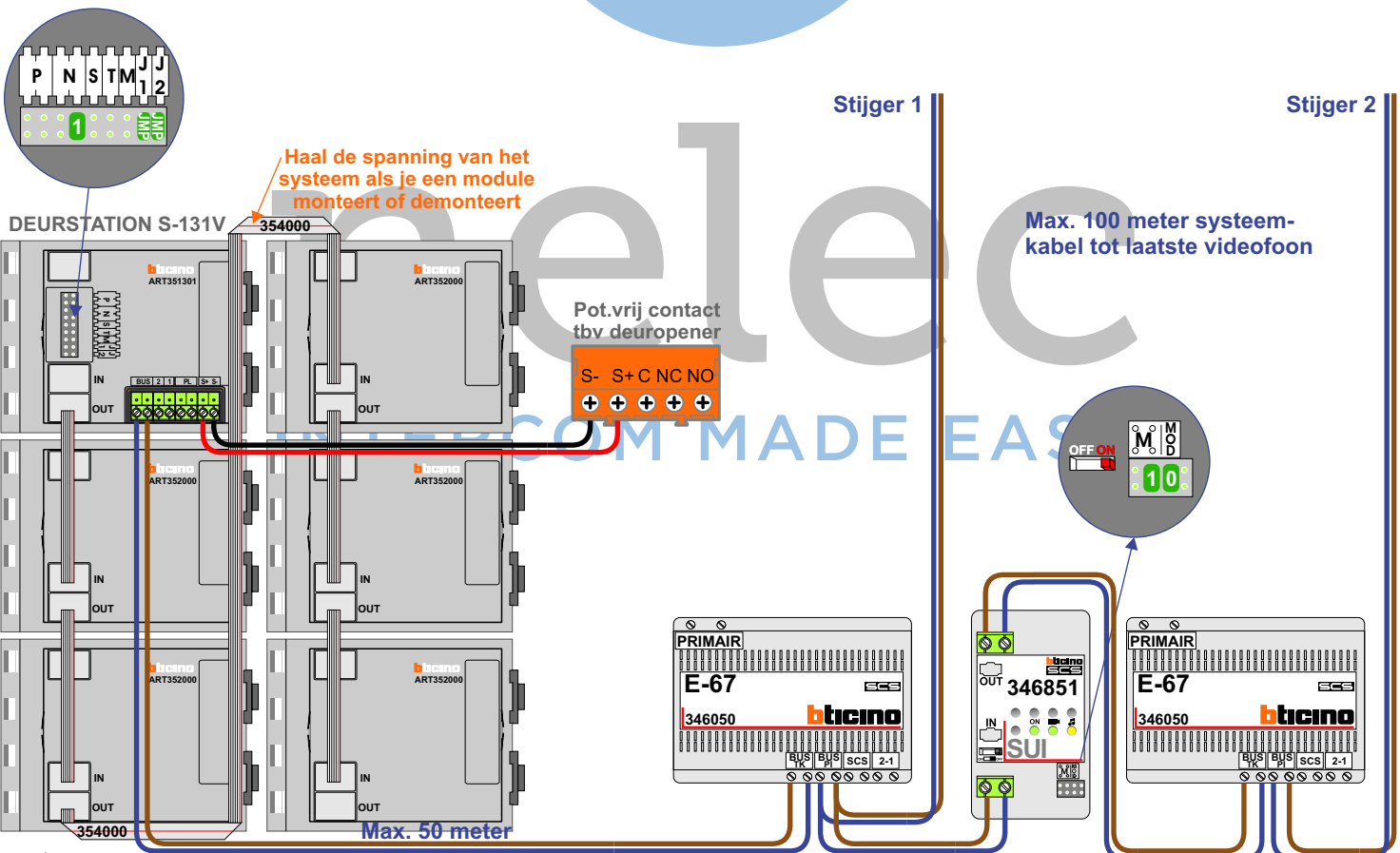

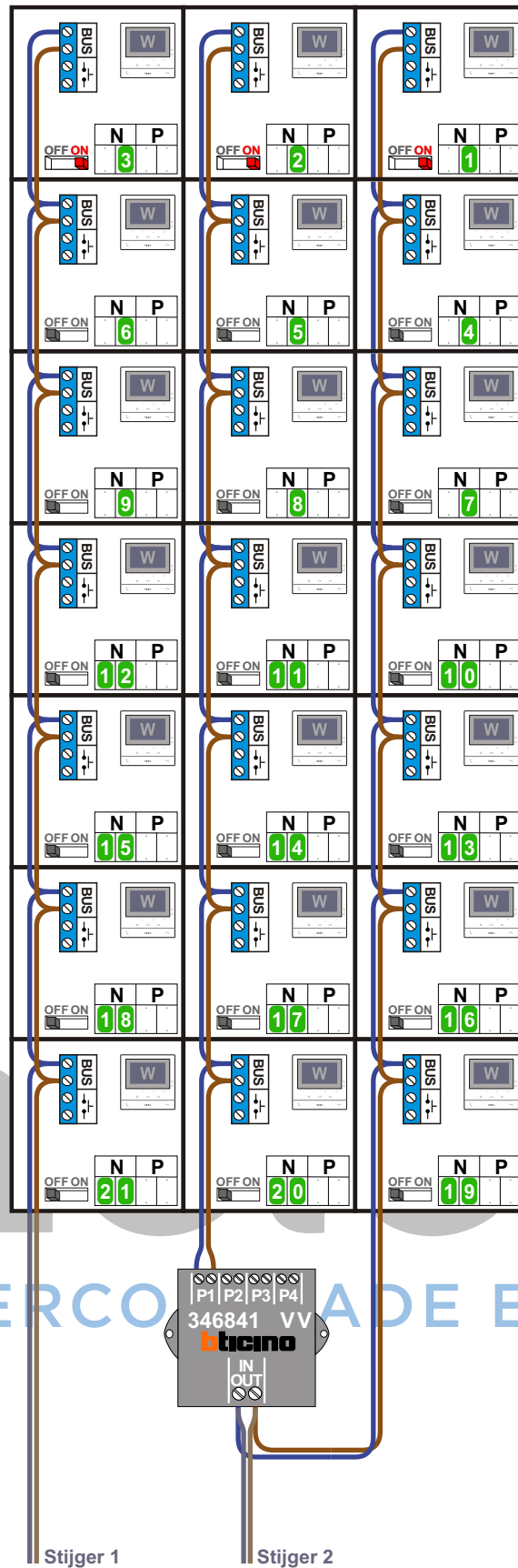
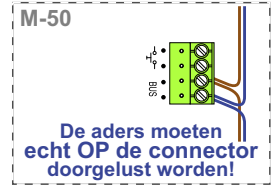

nelec
INTERCOM MADE EASY

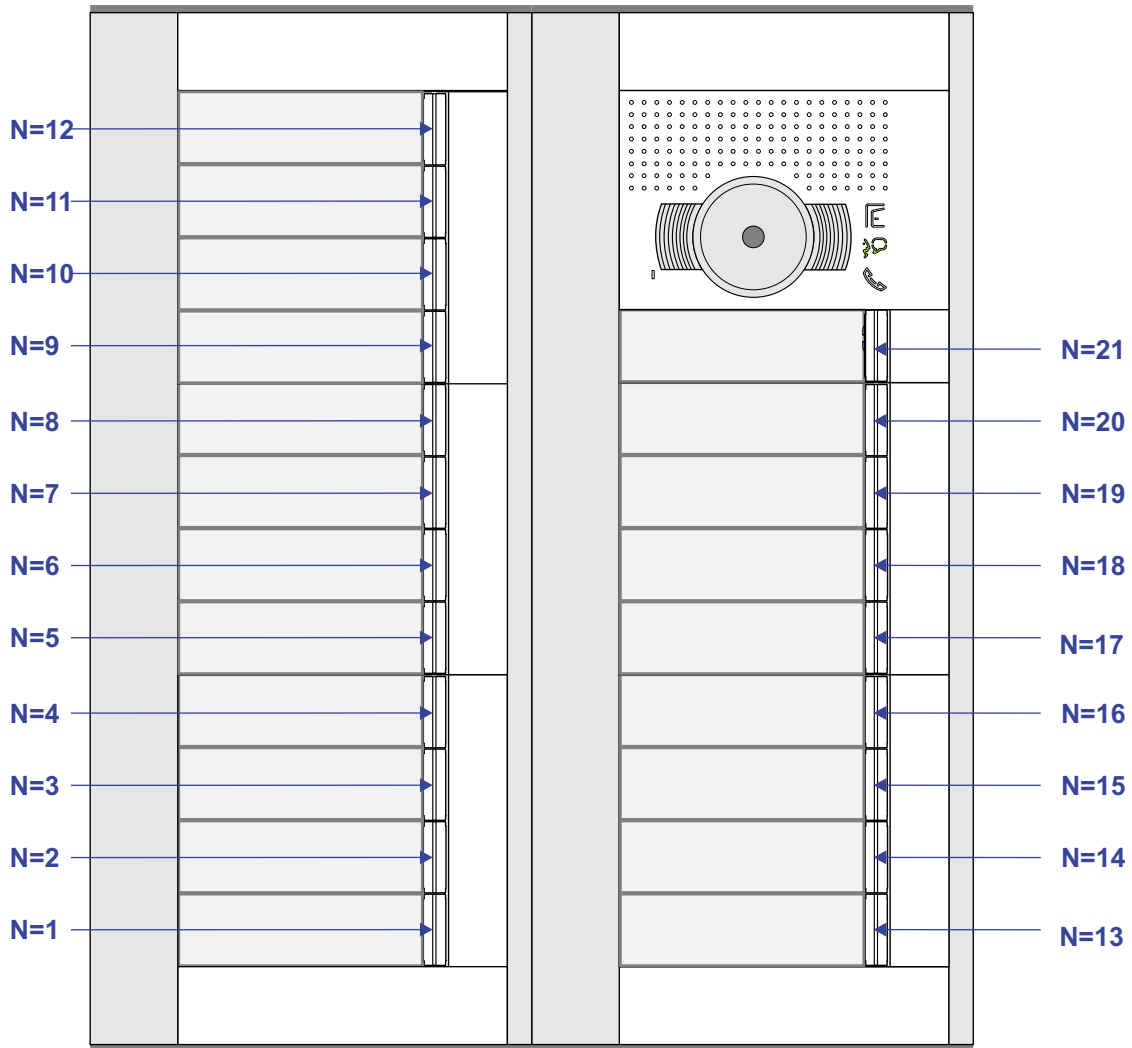

N-waarde	Huisnummer	Eindweerstand
1	341	X
2	339	X
3	337	X
4	335	
5	333	
6	331	
7	329	
8	327	
9	325	
10	323	
11	321	
12	319	
13	317	
14	315	
15	313	
16	311	
17	309	
18	307	
19	305	
20	303	
21	301	

nelec
INTERCOM MADE EASY

— = systeemkabel
 Bij andere getwiste kabel 66% afstand!
 Bij ongetwiste kabel max. 50 meter buitenpost naar videofoon.
 UTP op aanvraag.

TWEEDRAADS BUS



Bij monteren/demonteren spanning eraf voorkomt defecten!

M-50

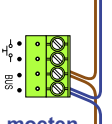

De aders moeten echt OP de connector doorgelust worden!

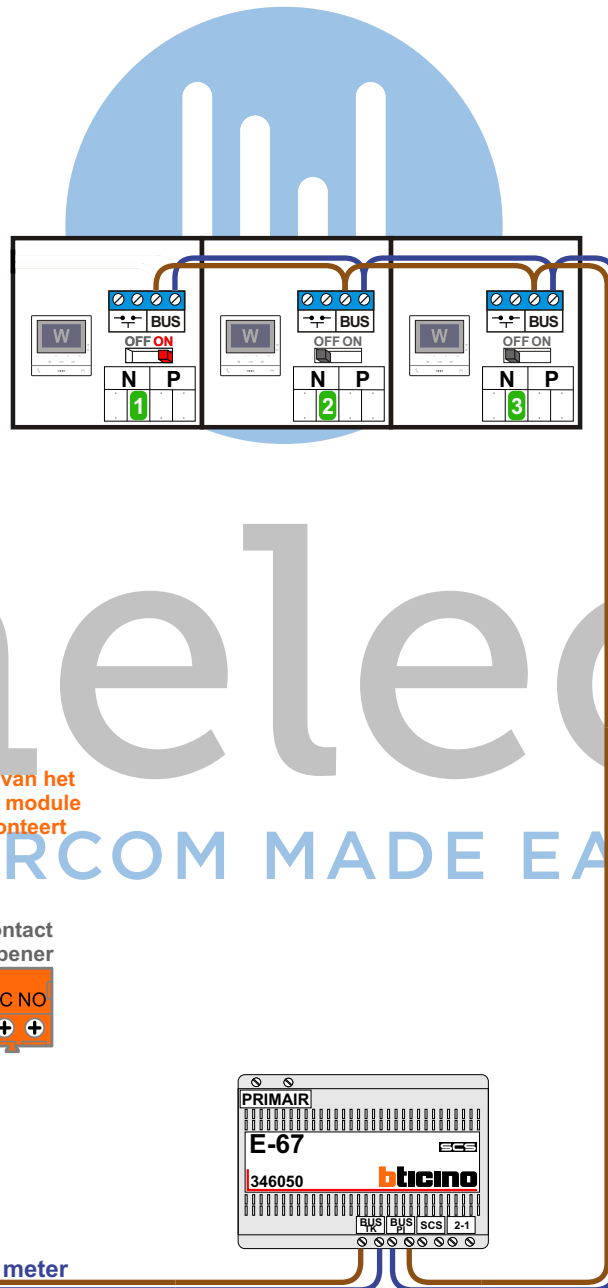

Haal de spanning van het systeem als je een module monteert of demonteert

INTERCOM MADE EASY

nelec

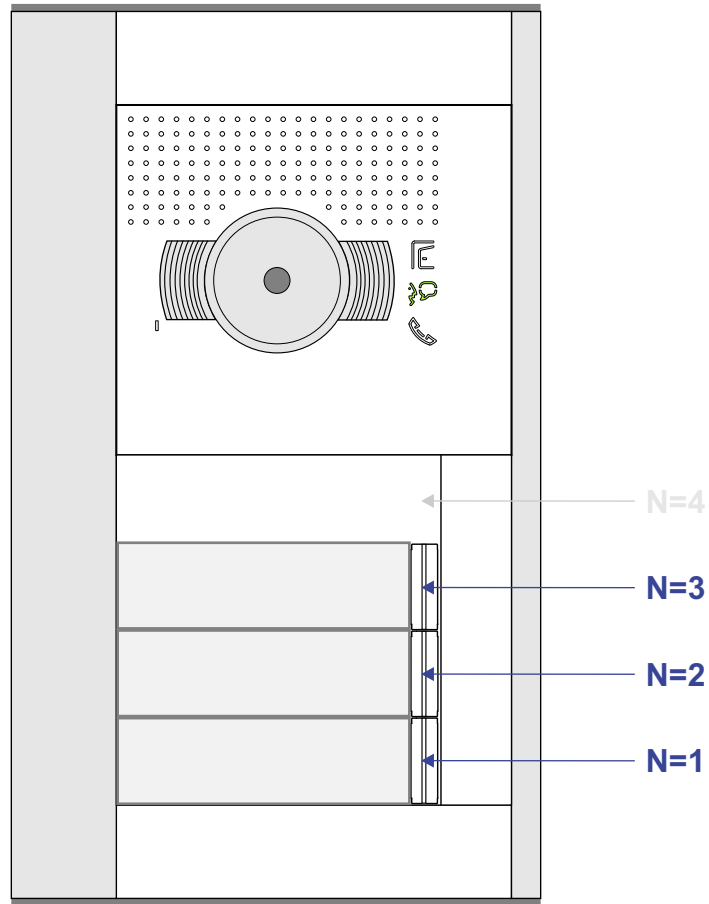

nelec

N-waarde	Huisnummer	Eindweerstand
1	343	X
2	345	
3	347	

INTERCOM MADE EASY