



TWEEDRAADS BUS



Bij monteren/demonteren **spanning eraf** voorkomt defecten!

SUI



De aders moeten **echt OP de klemmen** doorgelust worden!

VideoVerdelers



De aders moeten **echt OP de klemmen** doorgelust worden!

Legend:
— = systeemkabel
Bij andere getwiste kabel **66%** afstand!
Bij ongetwiste kabel **max. 50 meter** buitenpost naar videofoon.
UTP op aanvraag.

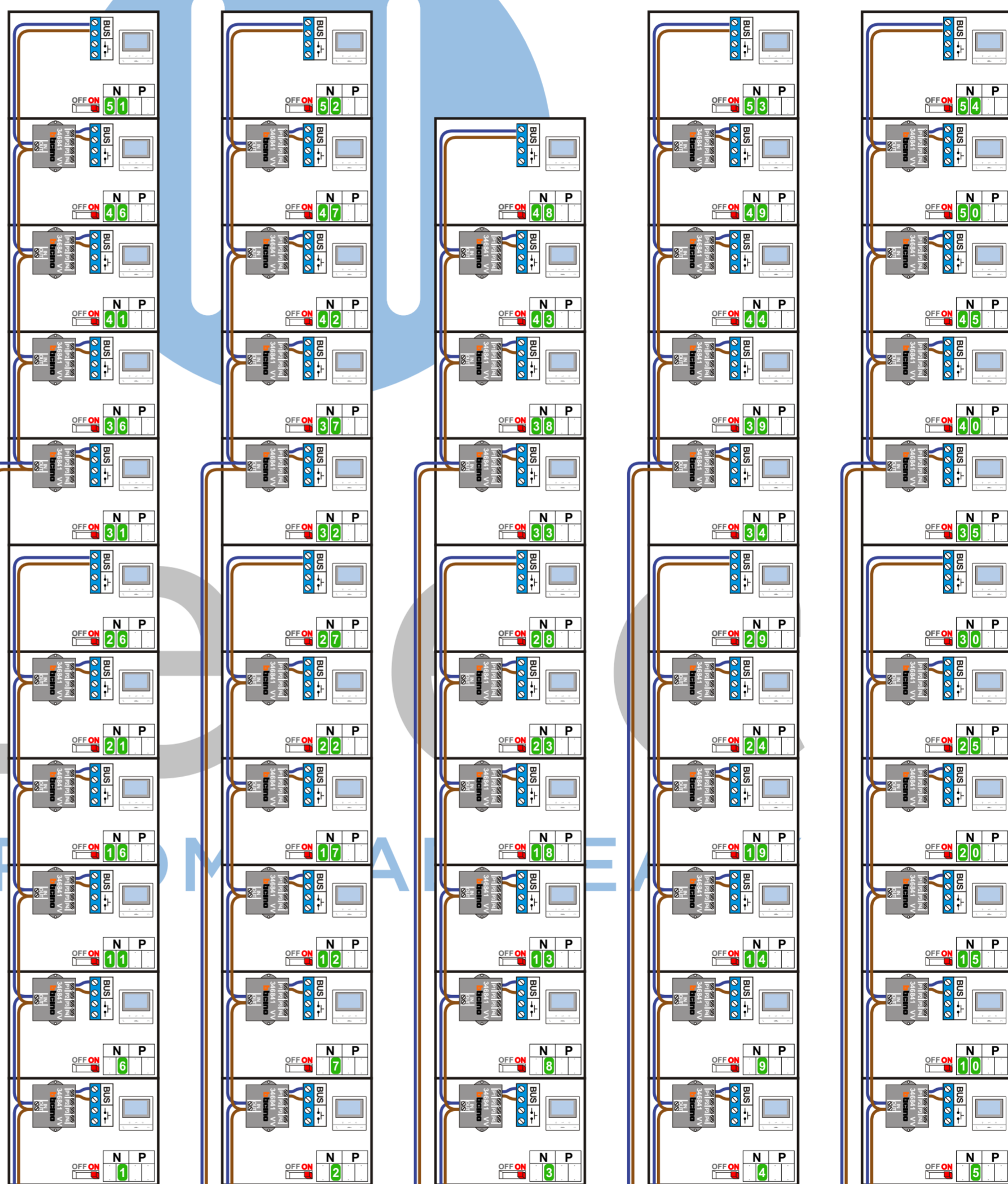
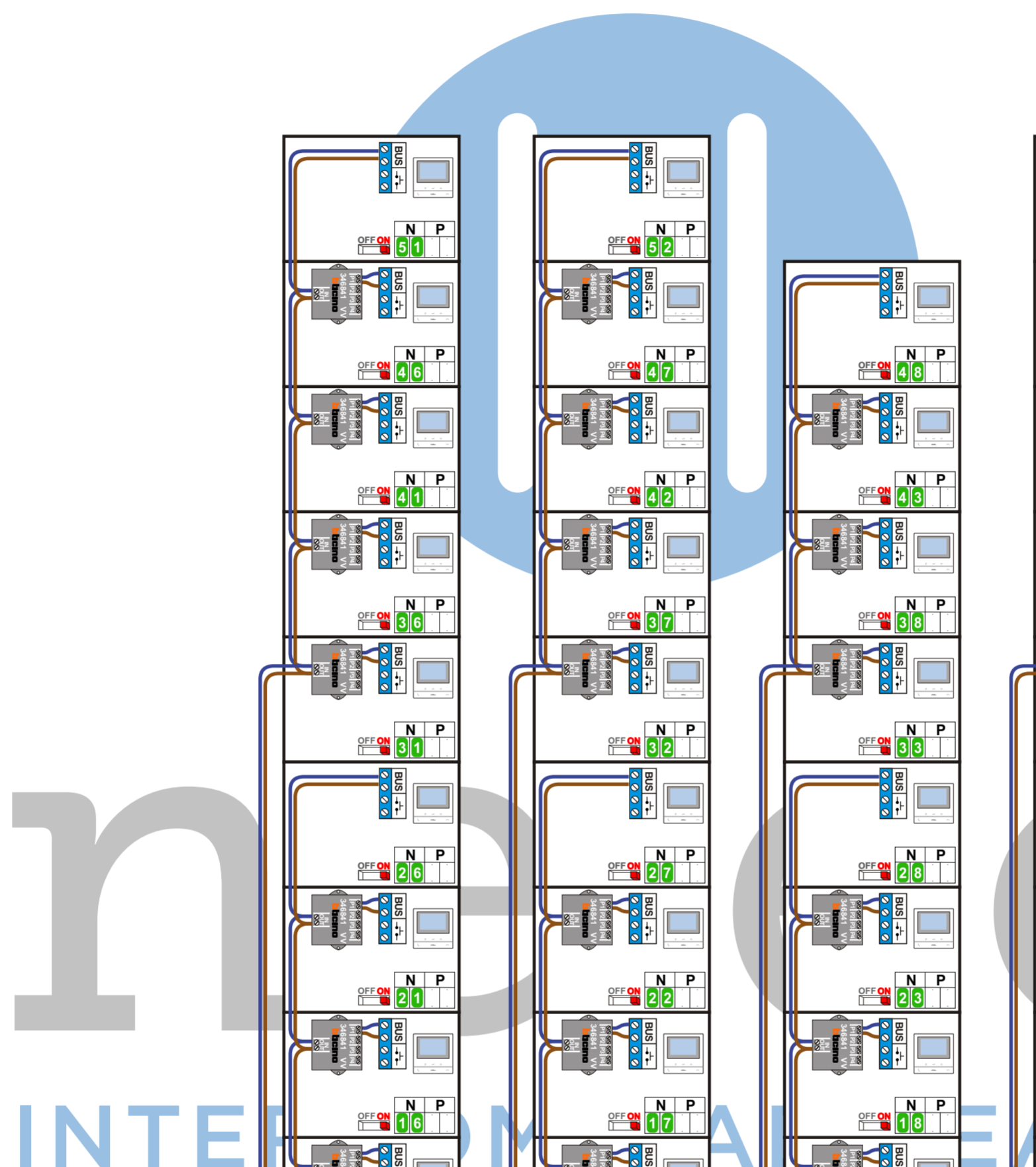

11e Verd.
10e Verd.
9e Verd.
8e Verd.
7e Verd.
6e Verd.
5e Verd.
4e Verd.
3e Verd.
2e Verd.
1e Verd.

Haal de spanning van het systeem als je een digitizer monteert of demonteert

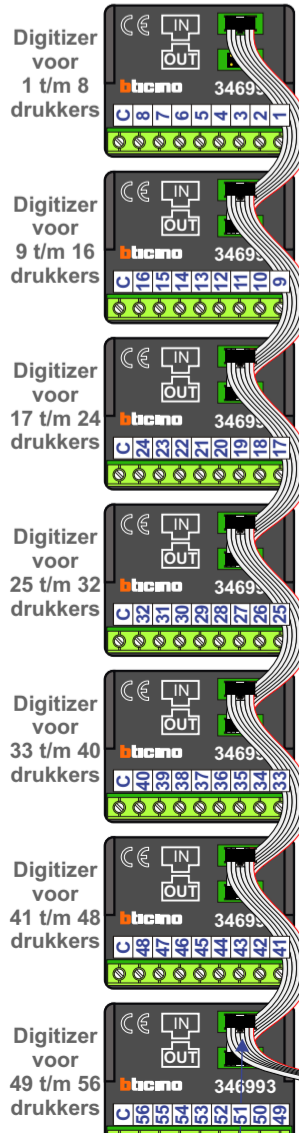

nokjes connectoren wijzen naar elkaar

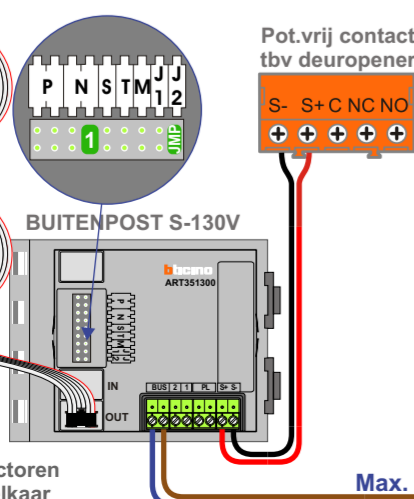

Max. 100 meter systeemkabel tot laatste videofoon

Max. 100 meter systeemkabel tot laatste videofoon

Max. 100 meter systeemkabel tot laatste videofoon

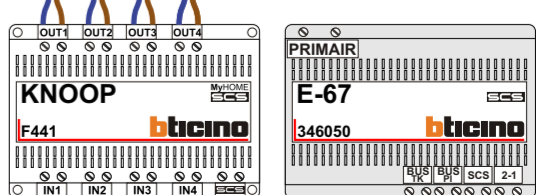
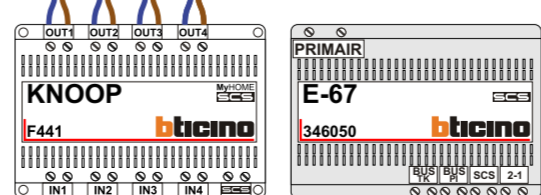
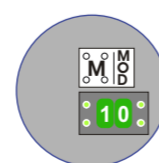
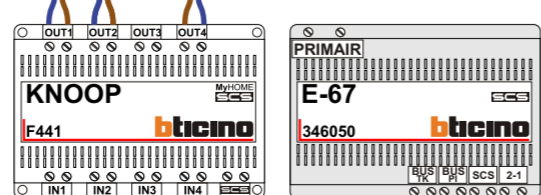

N-Waarde	Huisnummer	Switch-ON	N-Waarde	Huisnummer	Switch-ON
1	1	X	28	55	X
2	3	X	29	57	X
3	5	X	30	59	X
4	7	X	31	61	X
5	9	X	32	63	X
6	11	X	33	65	X
7	13	X	34	67	X
8	15	X	35	69	X
9	17	X	36	71	X
10	19	X	37	73	X
11	21	X	38	75	X
12	23	X	39	77	X
13	25	X	40	79	X
14	27	X	41	81	X
15	29	X	42	83	X
16	31	X	43	85	X
17	33	X	44	87	X
18	35	X	45	89	X
19	37	X	46	91	X
20	39	X	47	93	X
21	41	X	48	95	X
22	43	X	49	97	X
23	45	X	50	99	X
24	47	X	51	101	X
25	49	X	52	103	X
26	51	X	53	105	X
27	53	X	54	107	X