

**— = systeemkabel**  
 Bij andere getwiste kabel 66% afstand!  
 Bij ongetwiste kabel max. 50 meter buitenpost naar videofoon.  
 UTP op aanvraag.

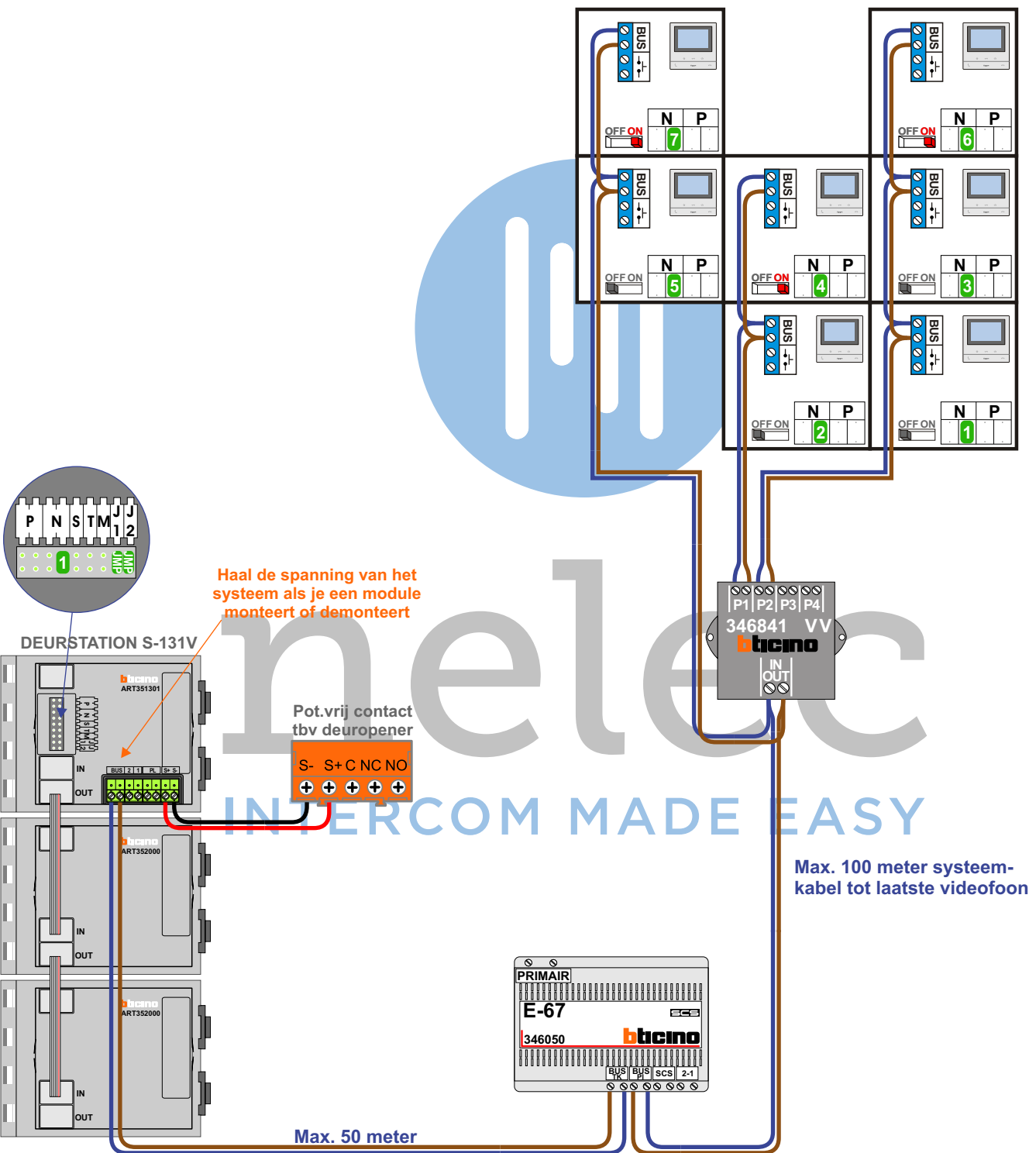

**TWEEDRAADS BUS**

Bij monteren/demonteren spanning eraf voorkomt defecten!



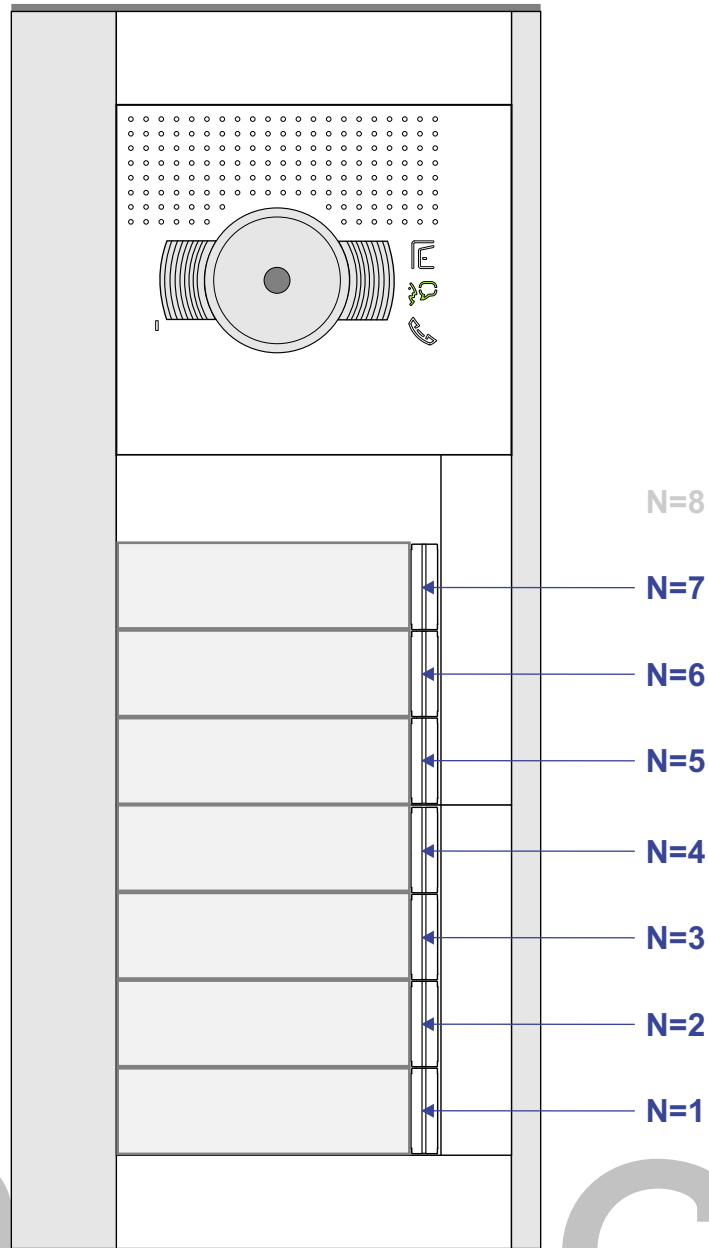

nelec

N-waarde	Huisnummer	Endweerstand
1	50	
2	50A	
3	50B	
4	50C	X
5	50D	
6	50E	X
7	50F	X

**— = systeemkabel**  
 Bij andere getwiste kabel 66% afstand!  
 Bij ongetwiste kabel max. 50 meter buitenpost naar videofoon.  
 UTP op aanvraag.

**TWEEDRAADS BUS**



Bij monteren/demonteren spanning eraf voorkomt defecten!

**M-50**



De aders moeten echt OP de connector doorgelust worden!

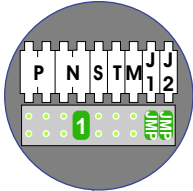
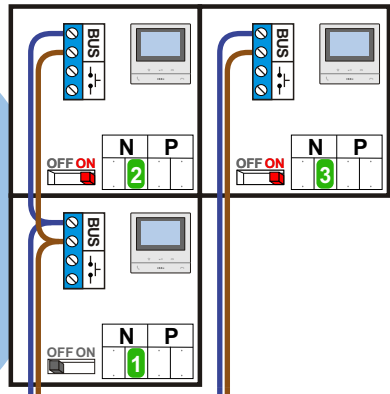

Haal de spanning van het systeem als je een module monteert of demonteert

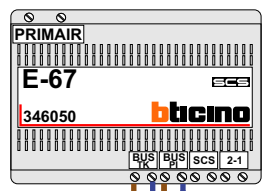
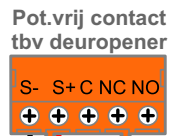
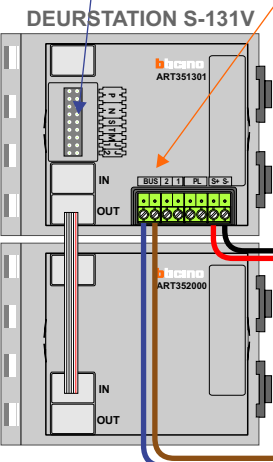

Max. 50 meter

Max. 100 meter systeemkabel tot laatste videofoon

nelec  
INTERCOM MADE EASY

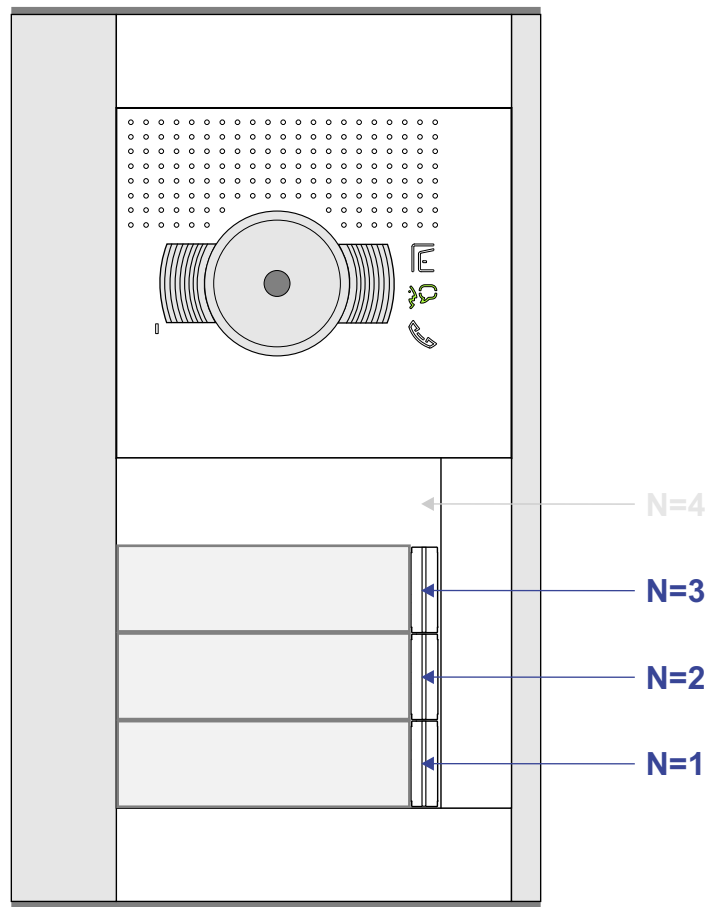

N-waarde	Huisnummer	Endweerstand
1	48	
2	48A	X
3	48B	X

nelec  
INTERCOM MADE EASY