

— = systeemkabel
Bij andere getwiste kabel 66% afstand!
Bij ongetwiste kabel max. 50 meter buitenpost naar videofoon.
UTP op aanvraag.

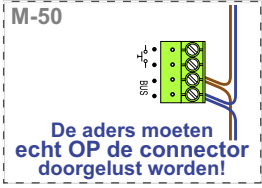

TWEEDRAADS BUS



Bij monteren/demonteren spanning eraf voorkomt defecten!

Digitizers & flatcables

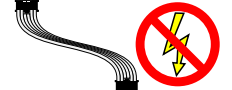

Niet monteren/demonteren onder spanning Beldrukkers mogen wel!

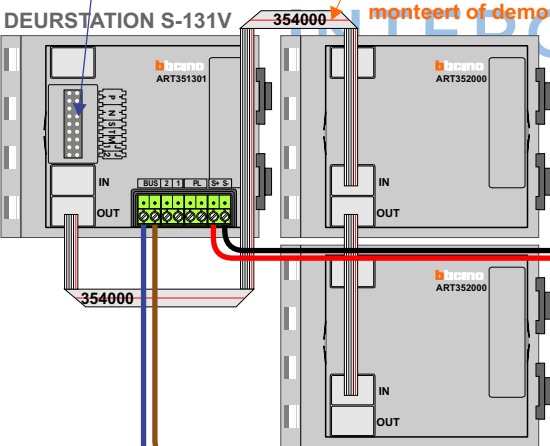
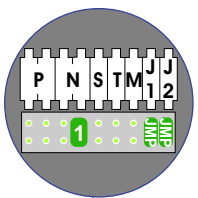
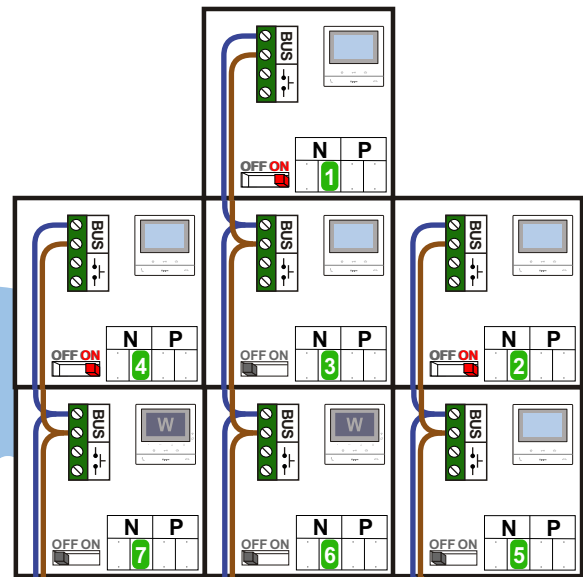

Haal de spanning van het systeem als je een module monteert of demonteert

Pot.vrij contact tbv deurpener

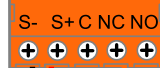

Max. 100 meter systeemkabel tot laatste videofoon

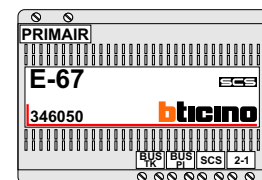

Max. 50 meter

 = **stroomkabel**
 Bij andere getwiste kabel 66% afstand!
 Bij ongetwiste kabel max. 50 meter buitenpost naar videofoon.
 UTP op aanvraag.

TWEEDRAADS BUS
 
 Bij monteren/demonteren spanning eraf voorkomt defecten!

N-Waarde	Huisnummer	Switch-ON	Videofoon
1	16	X	M-50B
2	15	X	M-50B
3	14		M-50B
4	13	X	M-50B
5	12		M-50B
6	11		M-50W ifi
7	10		M-50W ifi

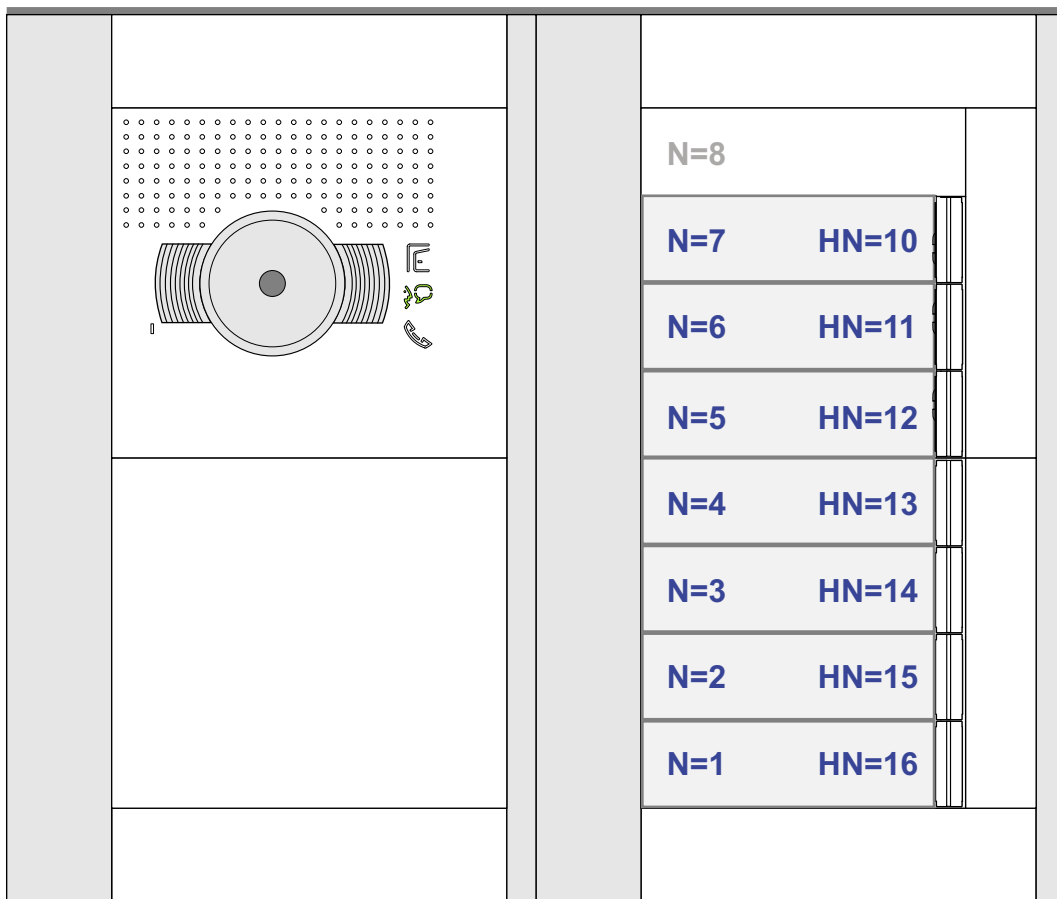

— = systeemkabel
Bij andere getwiste kabel 66% afstand!
Bij ongetwiste kabel max. 50 meter buitenpost naar videofoon.
UTP op aanvraag.

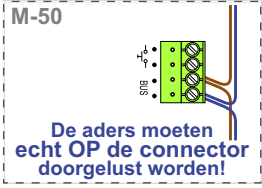



TWEEDRAADS BUS

Bij monteren/demonteren spanning eraf voorkomt defecten!

Digitizers & flatcables

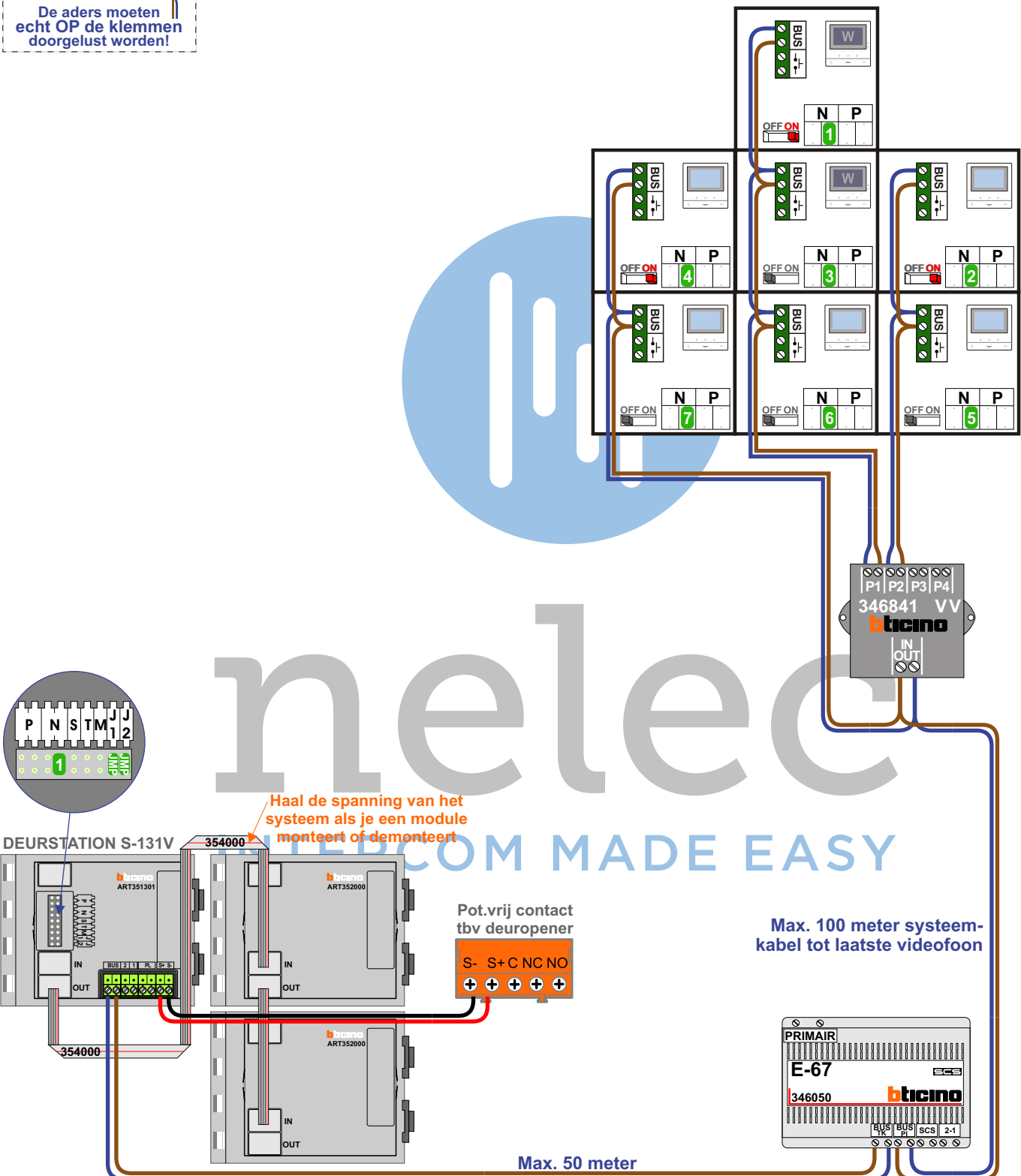
Niet monteren/demonteren onder spanning
Beldrukkers mogen wel



 = **stroomkabel**
 Bij andere getwiste kabel 66% afstand!
 Bij ongetwiste kabel max. 50 meter buitenpost naar videofoon.
 UTP op aanvraag.

TWEEDRAADS BUS
 
 Bij monteren/demonteren spanning eraf voorkomt defecten!

N-Waarde	Huisnummer	Switch-ON	Videofoon
1	26	X	M-50W ifi
2	25	X	M-50B
3	24		M-50W ifi
4	23	X	M-50B
5	22		M-50B
6	21		M-50B
7	20		M-50B

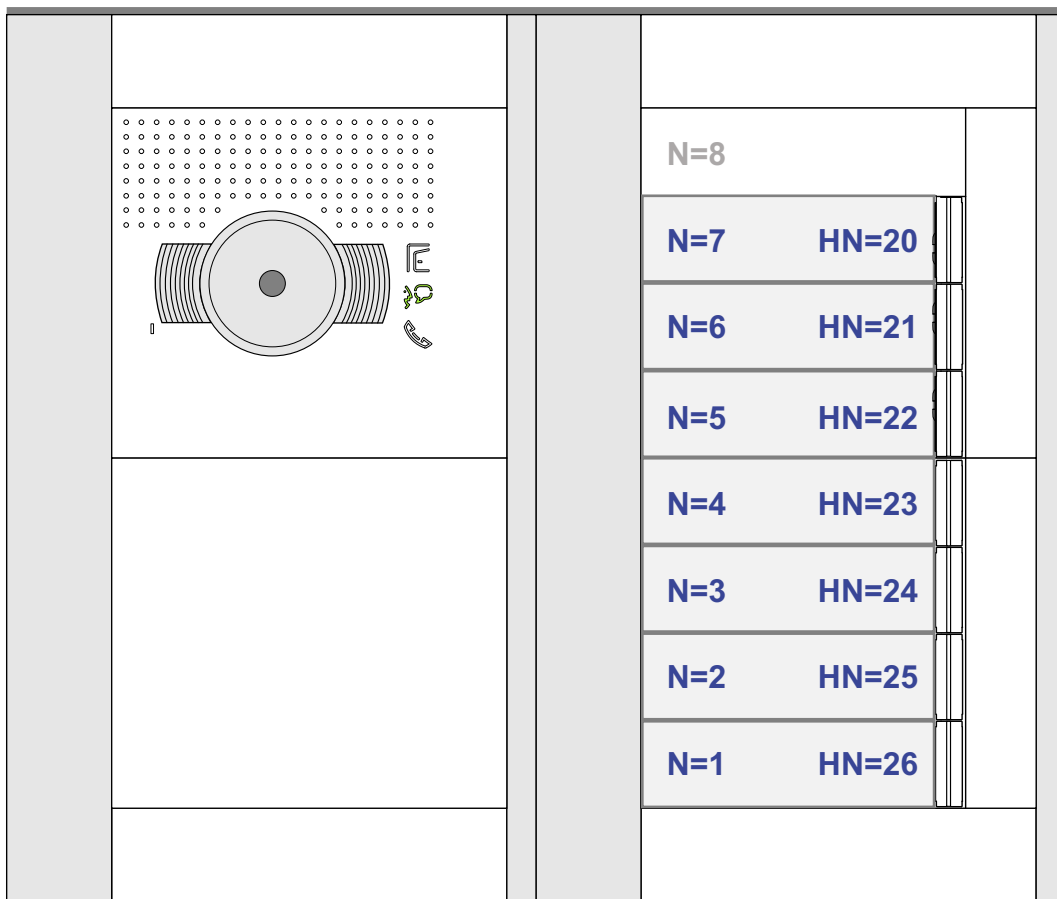

— = systeemkabel
Bij andere getwiste kabel 66% afstand!
Bij ongetwiste kabel max. 50 meter buitenpost naar videofoon.
UTP op aanvraag.

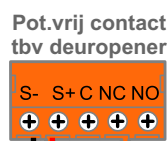
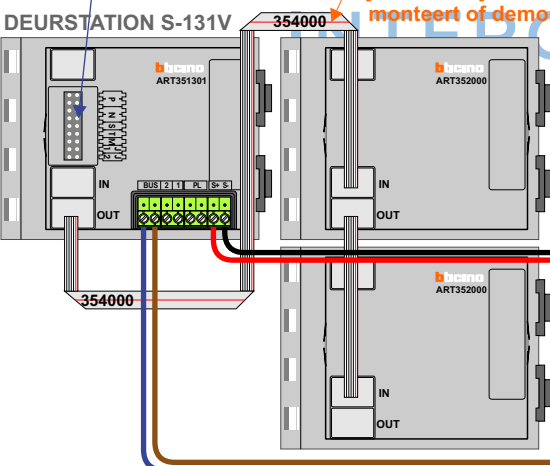
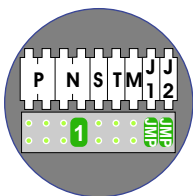
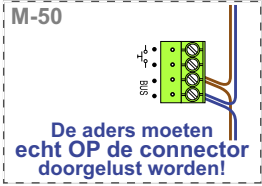

Max. 100 meter systeemkabel tot laatste videofoon

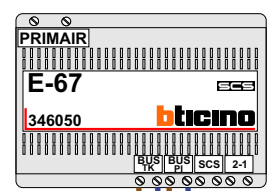

Max. 50 meter

TWEEDRAADS BUS

Bij monteren/demonteren spanning eraf voorkomt defecten!

Digitizers & flatcables

Niet monteren/demonteren onder spanning
Beldrukkers mogen wel

M-50e M-50W
Bij hulpvoeding op 1-2: zet switch op ON

ON OFF 2-1

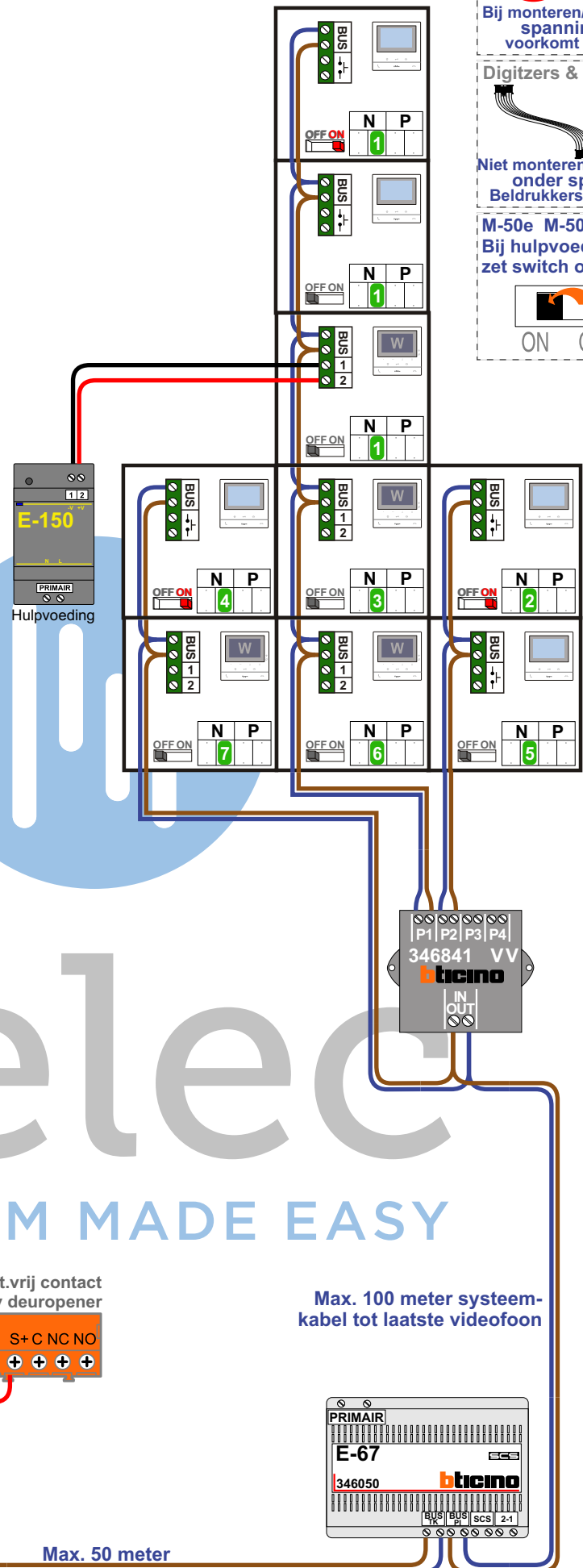

nelec
INTERCOM MADE EASY

 = **stroomkabel**
 Bij andere getwiste kabel 66% afstand!
 Bij ongetwiste kabel max. 50 meter buitenpost naar videofoon.
 UTP op aanvraag.

TWEEDRAADS BUS
 
 Bij monteren/demonteren spanning eraf voorkomt defecten!

N-Waarde	Huisnummer	Switch-ON	Videofoon
1	36	X	M-50W ifi
2	35	X	M-50B
3	34		M-50W ifi
4	33	X	M-50B
5	32		M-50B
6	31		M-50W ifi
7	30		M-50W ifi

