

— = systeemkabel
Bij andere getwiste kabel 66% afstand!
Bij ongetwiste kabel max. 50 meter buitenpost naar videofoon.
UTP op aanvraag.

VideoVerdeler



De aders moeten echt **OP** de klemmen doorgelust worden!

Digitizers & flatcables

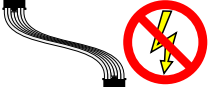

Niet monteren/demonteren onder spanning
Bedrukkers mogen wel

TWEEDRAADS BUS

Bij monteren/demonteren spanning eraf voorkomt defecten!

De twee stijgers echt **OP** de klemmen van E-67 aansluiten!

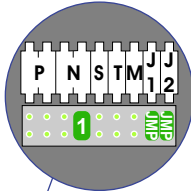

Haal de spanning van het systeem als je een module monteert of demonteert

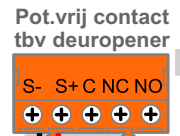
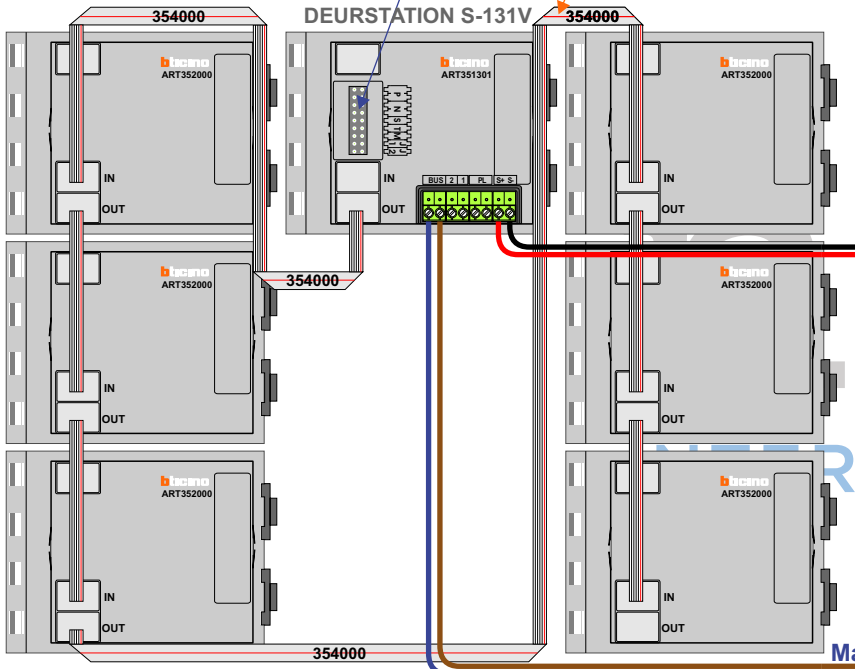

Max. 100 meter systeemkabel tot laatste videofoon

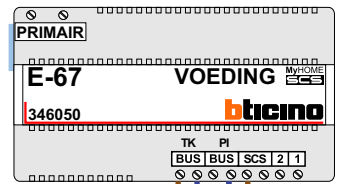

Max. 50 meter

Naar pagina 2

Naar pagina 2

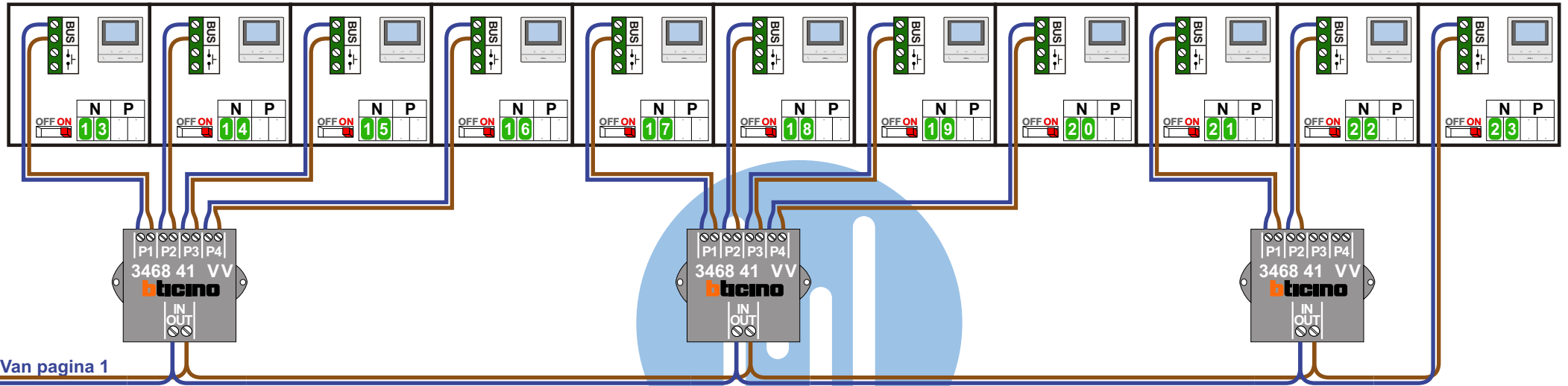

Van pagina 1

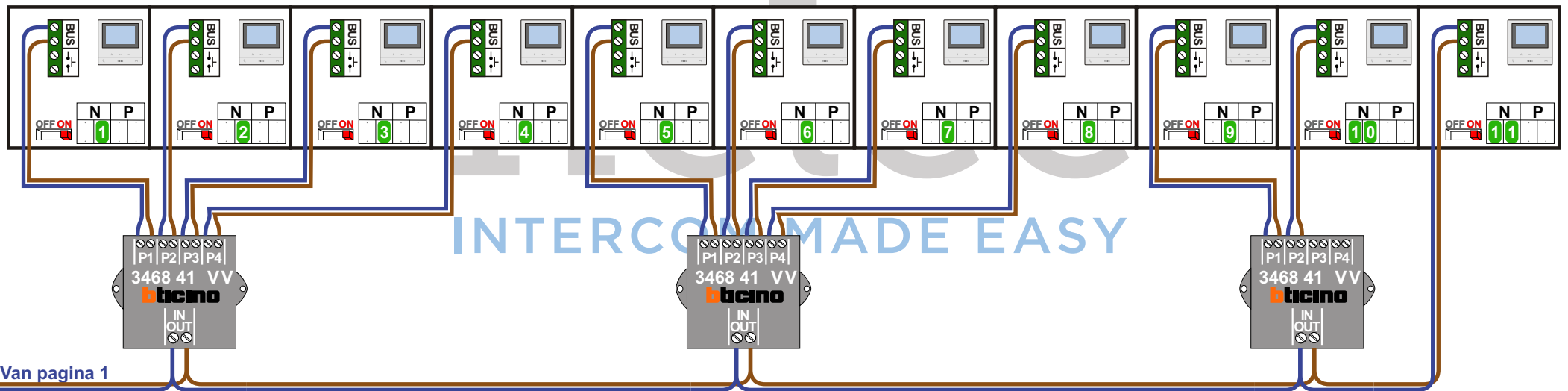

Van pagina 1

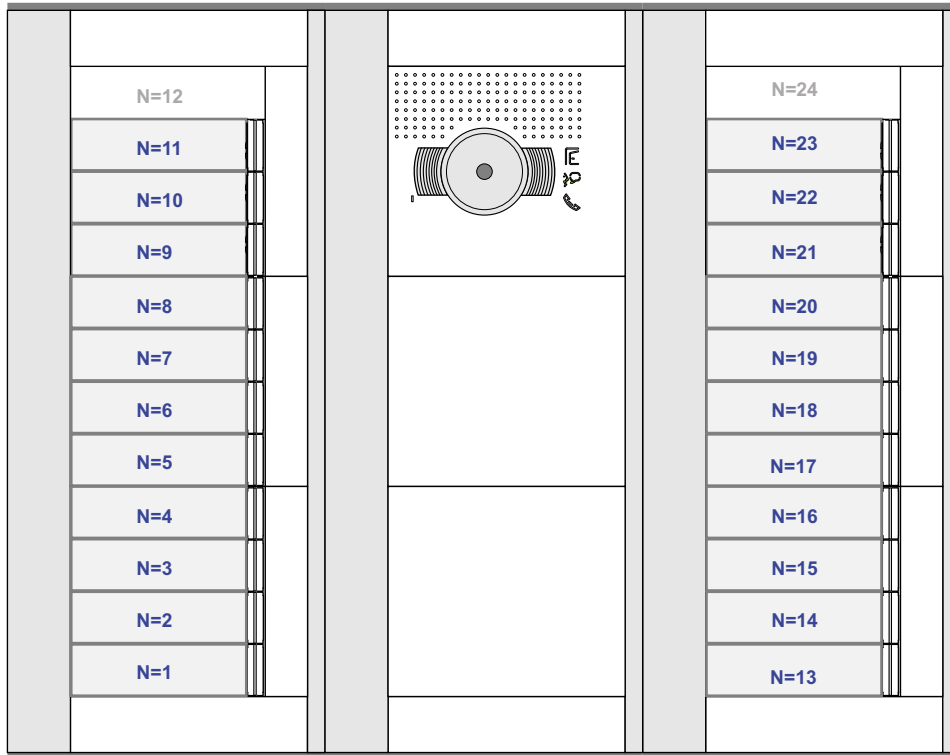

N-waarde	Appartement	Eindweerstand
1	1	X
2	2	X
3	3	X
4	4	X
5	5	X
6	6	X
7	7	X
8	8	X
9	9	X
10	10	X
11	11	X
13	12	X
14	13	X
15	14	X
16	15	X
17	16	X
18	17	X
19	18	X
20	19	X
21	20	X
22	21	X
23	22	X

INTERCOM MADE EASY