



**— = systeemkabel**  
 Bij andere getwiste kabel 66% afstand!  
 Bij ongetwiste kabel max. 50 meter buitenpost naar videofoon.  
 UTP op aanvraag.



**De twee stijgers echt OP de klemmen van E-67 aansluiten!**

**TWEEDRAADS BUS**



**Bij monteren/demonteren spanning eraf voorkomt defecten!**

**M-50**



**De aders moeten echt OP de connector doorgelust worden!**

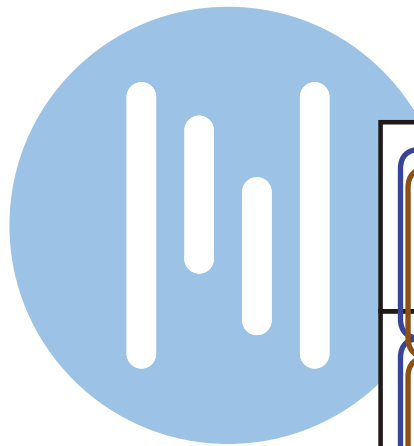

nelec  
INTERCOM MADE EASY

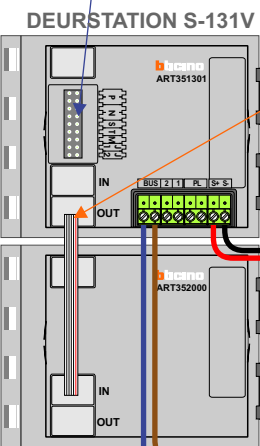
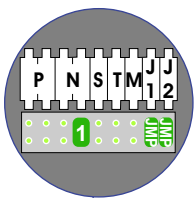

Haal de spanning van het systeem als je een module monteert of demonteert

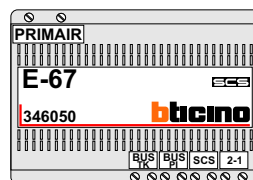

Max. 50 meter

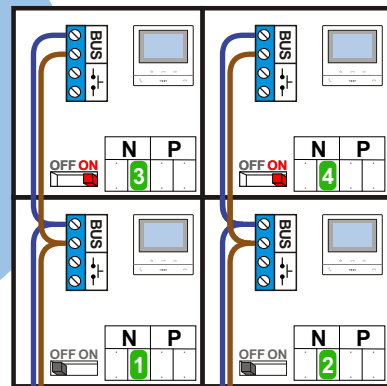

Max. 100 meter systeemkabel tot laatste videofoon

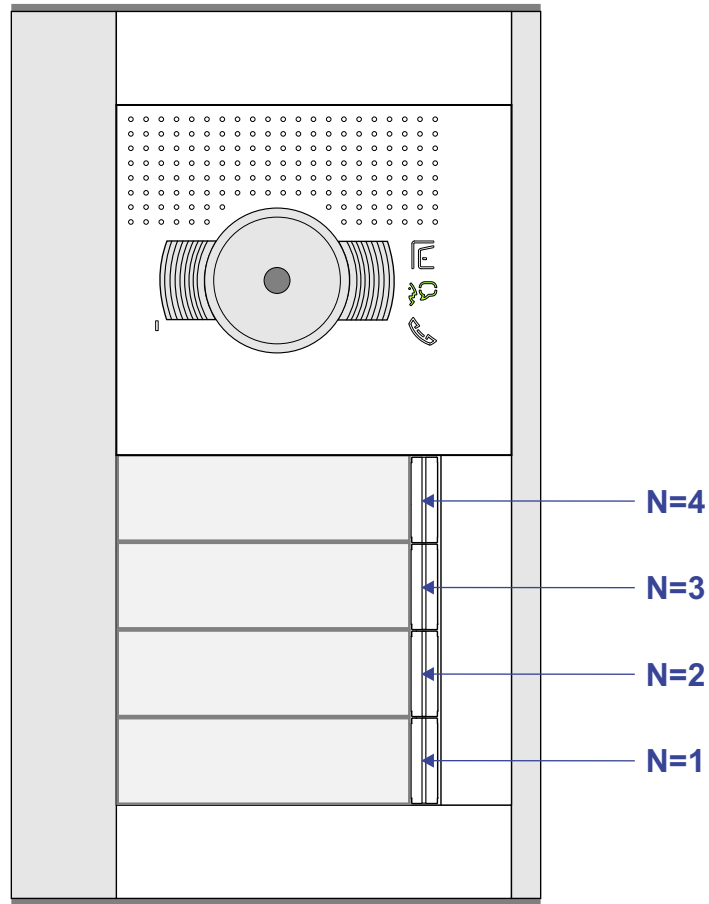

N-waarde	Huisnummer	Eindweerstand
1	43A	
2	43B	
3	43C	X
4	43D	X

nelec  
INTERCOM MADE EASY