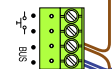

**— = systeemkabel**  
Bij andere getwiste kabel 66% afstand!  
Bij ongetwiste kabel max. 50 meter buitenpost naar videofoon.  
UTP op aanvraag.

**TWEEDRAADS BUS**  
  
Bij monteren/demonteren spanning eraf voorkomt defecten!

**VideoVerdeler**  
  
De aders moeten echt OP de klemmen doorgelust worden!

**M-50**  
  
De aders moeten echt OP de connector doorgelust worden!

**DD8 digitizer: flatcable**  
  
Connector van flatcable nokje juiste kant op bij aansluiten op DD8

**Digitizers & flatcables**  
  
Niet monteren/demonteren onder spanning  
Beldrukkers mogen wel

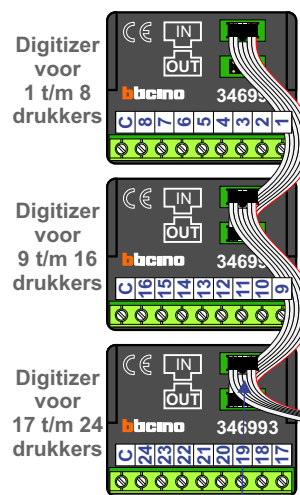
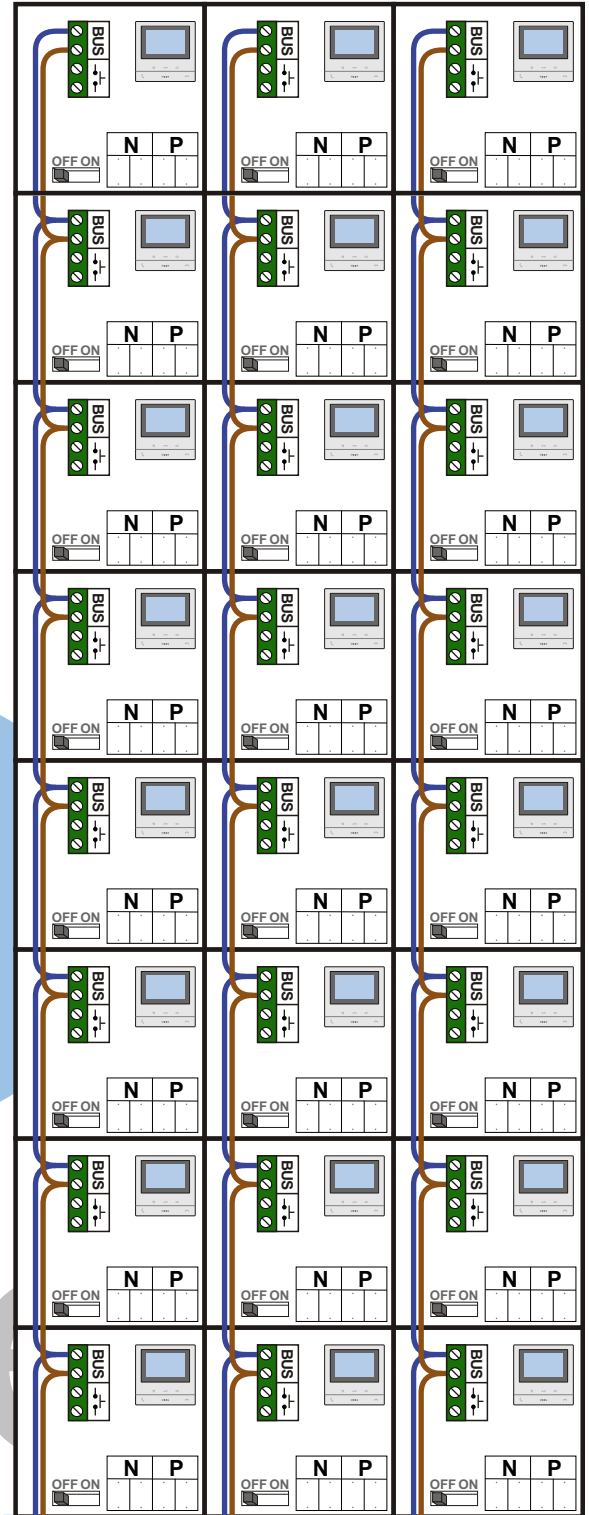

Haal de spanning van het systeem als je een digitizer monteert of demonteert

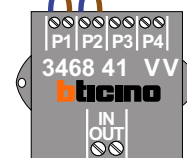
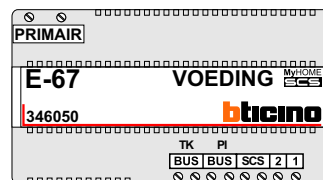
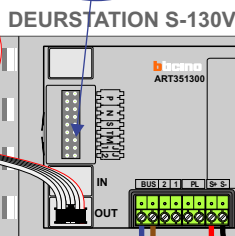
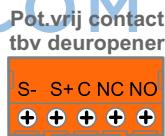
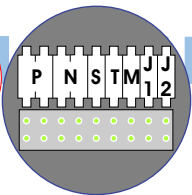

nokjes connectoren wijzen naar elkaar

Max. 50 meter

Max. 100 meter systeemkabel tot laatste videofoon

N-waarde	Huisnummers	Eindweerstand
1	2	
2	4	
3	6	
4	8	
5	10	
6	12	
7	14	
8	16	
9	18	
10	20	
11	22	
12	24	
13	26	
14	28	
15	30	
16	32	
17	34	
18	36	
19	38	
20	40	
21	42	
22	44	X
23	46	X
24	48	X

  
**nelec**  
 INTERCOM MADE EASY