 = systeemkabel  
Bij andere getwiste kabel 66% afstand!  
Bij ongetwiste kabel max. 50 meter buitenpost naar videofoon.  
UTP op aanvraag.

Digitizers & flatcables  
  
Niet monteren/demonteren onder spanning  
Bedrukkers mogen wel

TWEEDRAADS BUS  
   
Bij monteren/demonteren spanning eraf voorkomt defecten!

M-50  
  
De aders moeten echt OP de connector doorgelust worden!

346050 bticino  
  
De twee stijgers echt OP de klemmen van E-67 aansluiten!

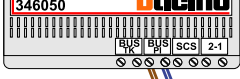
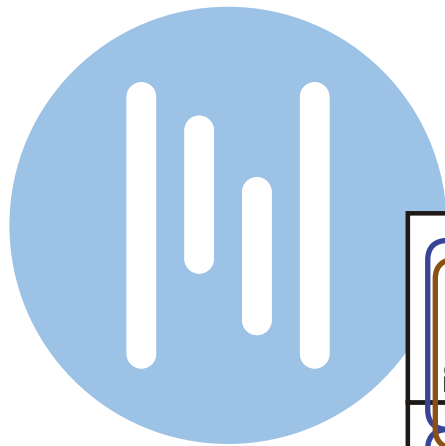

nelec  
INTERCOM MADE EASY

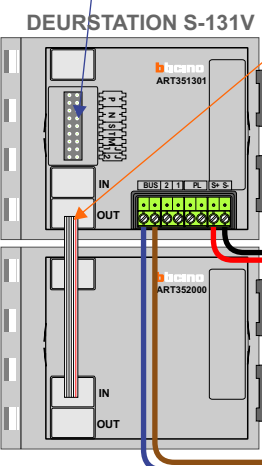
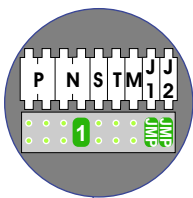

Haal de spanning van het systeem als je een module monteert of demonteert

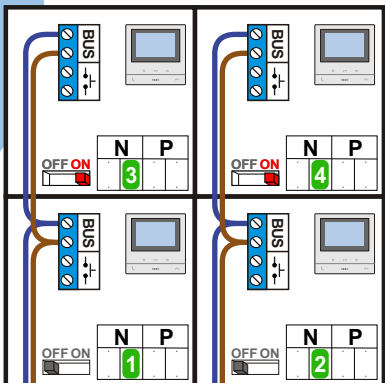
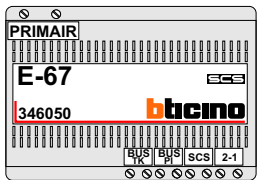

Max. 50 meter

Max. 100 meter systeemkabel tot laatste videofoon

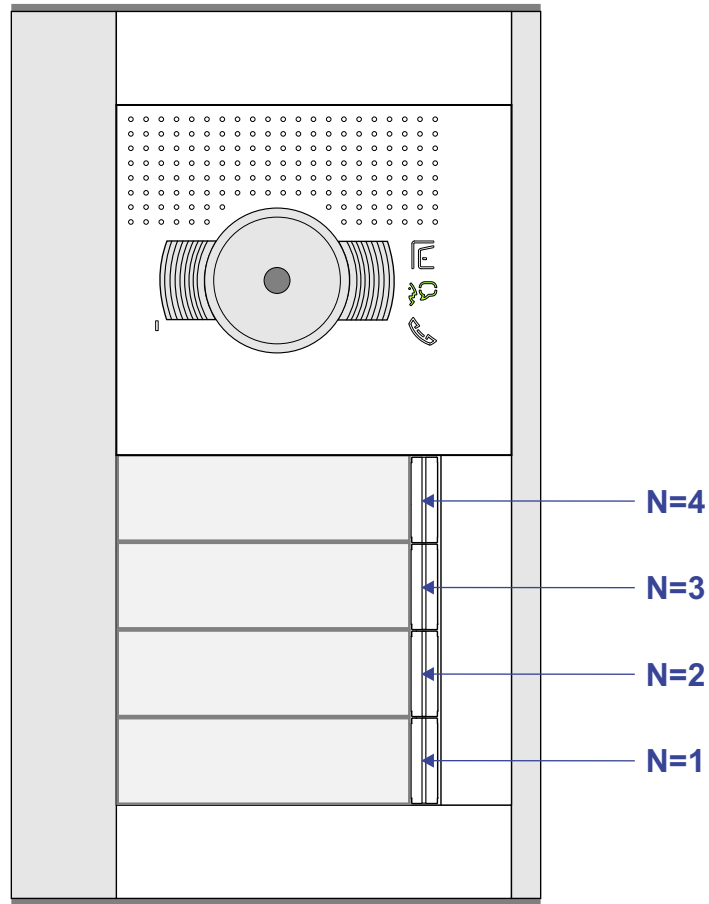

**Complex A**

N-Waarde	Huisnumm	Switch-ON
1	1	
2	3	
3	5	X
4	7	X

**Complex B**

N-Waarde	Huisnumm	Switch-ON
1	9	
2	11	
3	13	X
4	15	X