

**TWEEDRAADS BUS**  
Bij monteren/demonteren spanning eraf voorkomt defecten!

**— = systeemkabel**  
Bij andere getwiste kabel 66% afstand! Bij ongetwiste kabel max. 50 meter buitenpost naar videofoon. UTP op aanvraag.

**Digitizers & flatcables**  
Niet monteren/demonteren onder spanning! Belruikers mogen wel.

**SUI**  
De twee deurstations echt OP de klemmen van E-67 aansluiten!

**VideoVerdeeler**  
De aders moeten echt OP de connector doorgelust worden!

**M-50Wifi**  
De aders moeten echt OP de connector doorgelust worden!

**M-50Wifi**  
Bij hulpvoeding op 1-2: zet switch op ON

ON OFF 2-1

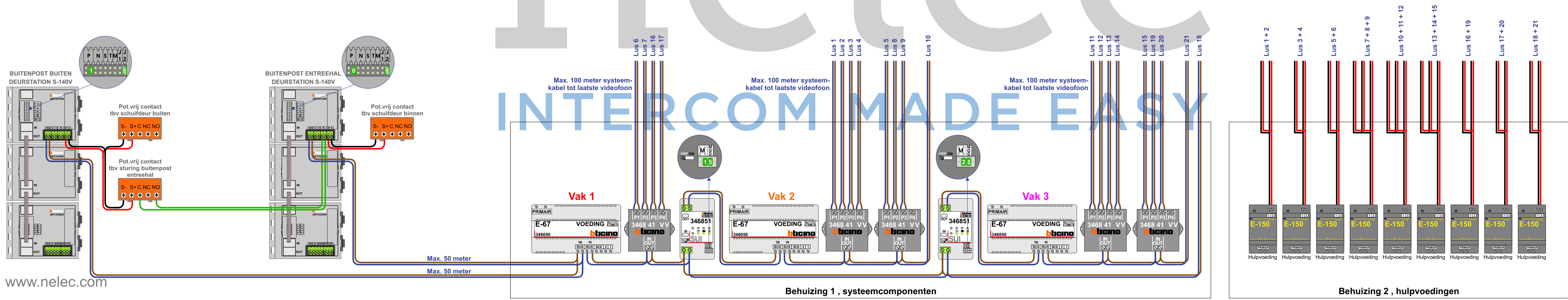

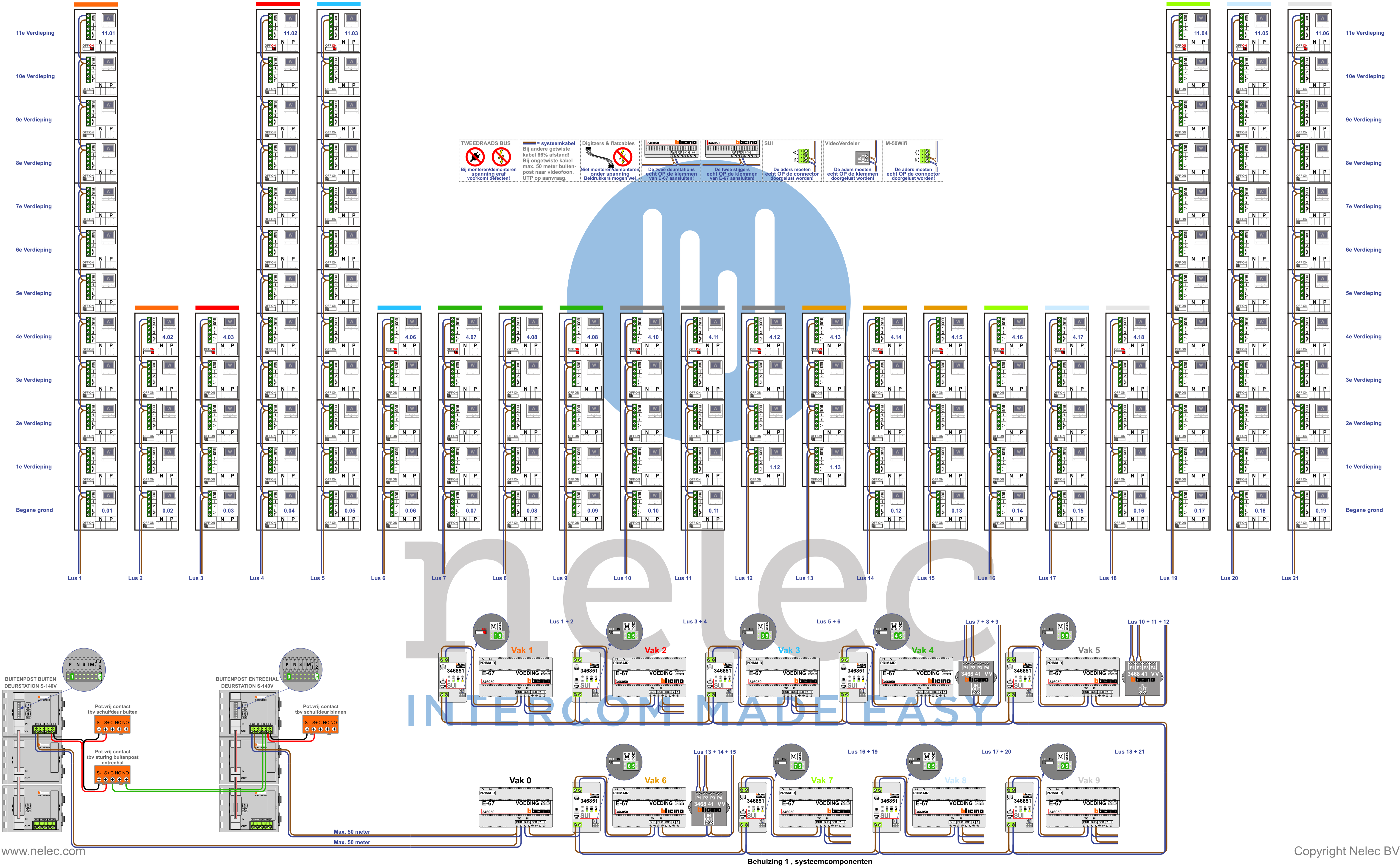

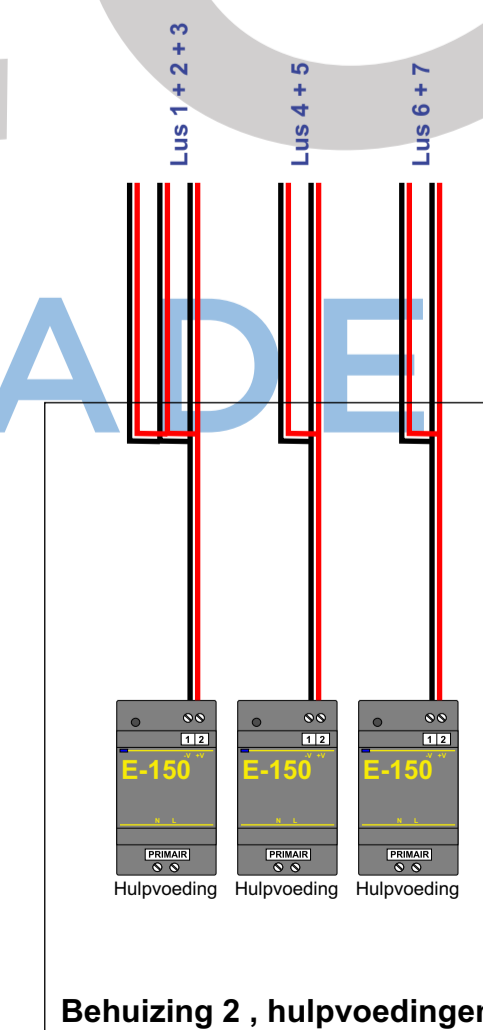
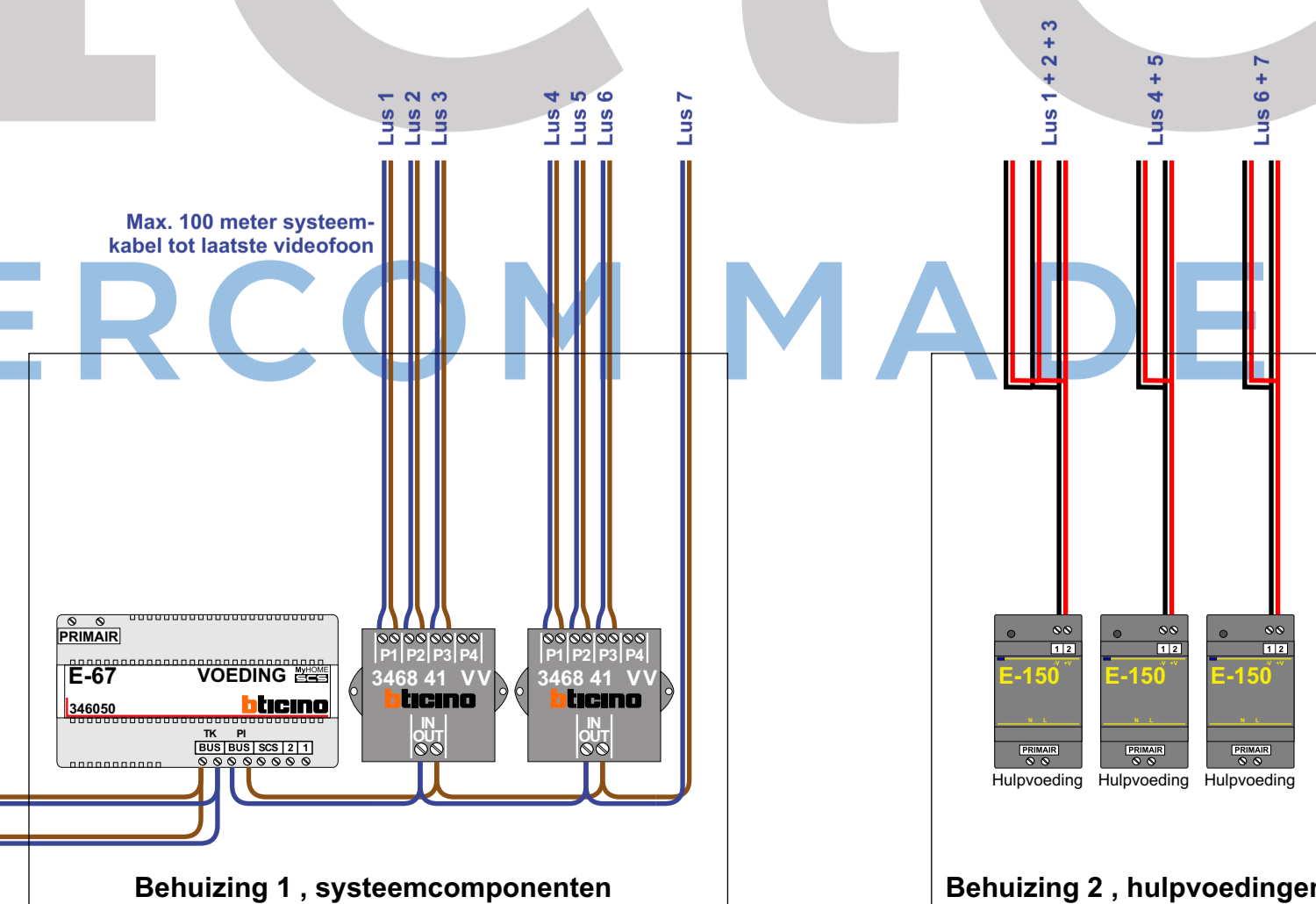
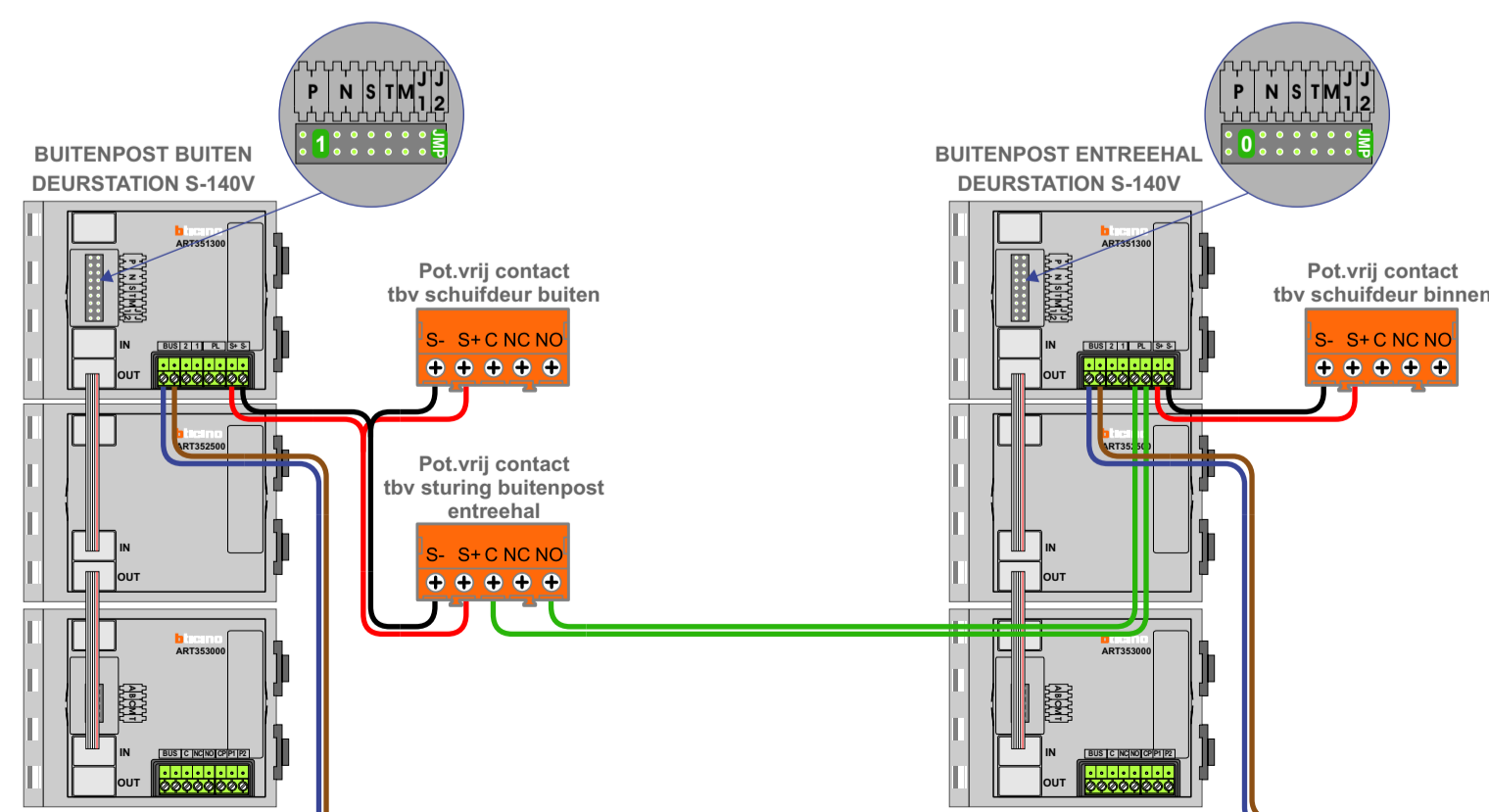
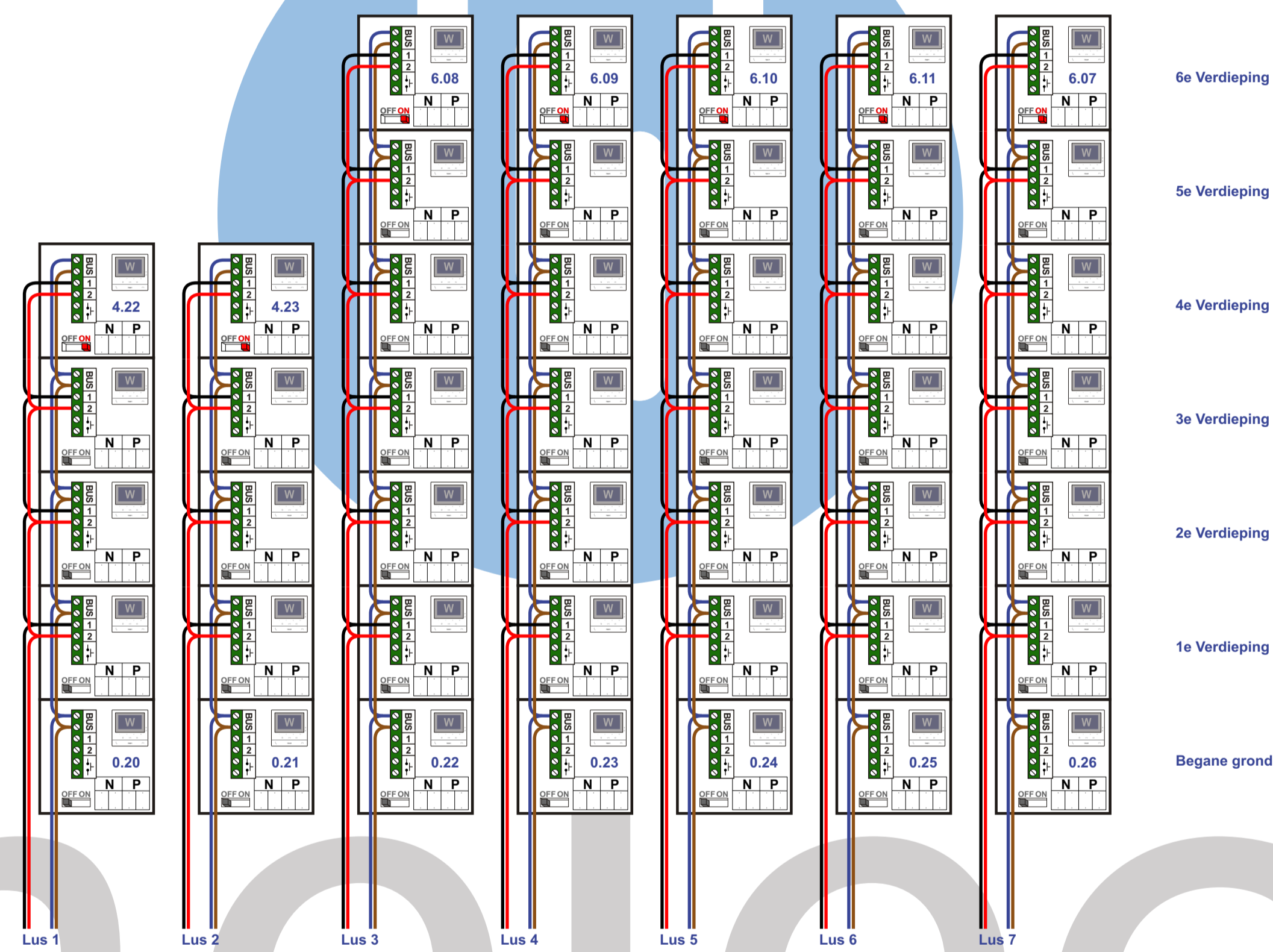

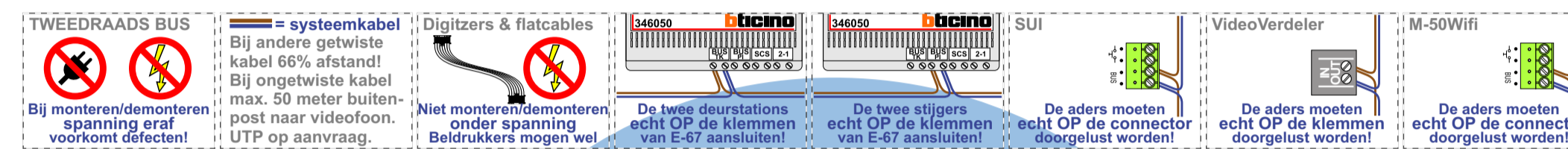

nelec  
INTERCOM MADE EASY

