

**— = systeemkabel**  
Bij andere getwiste kabel 66% afstand!  
Bij ongetwiste kabel max. 50 meter buitenpost naar videofoon.  
UTP op aanvraag.

TWEEDRAADS BUS



Bij monteren/demonteren **spanning eraf** voorkomt defecten!

DD8 digitizer: flatcable



M-50



Digitizers & flatcables



VideoVerdeler

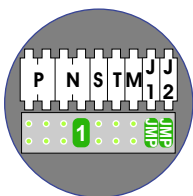
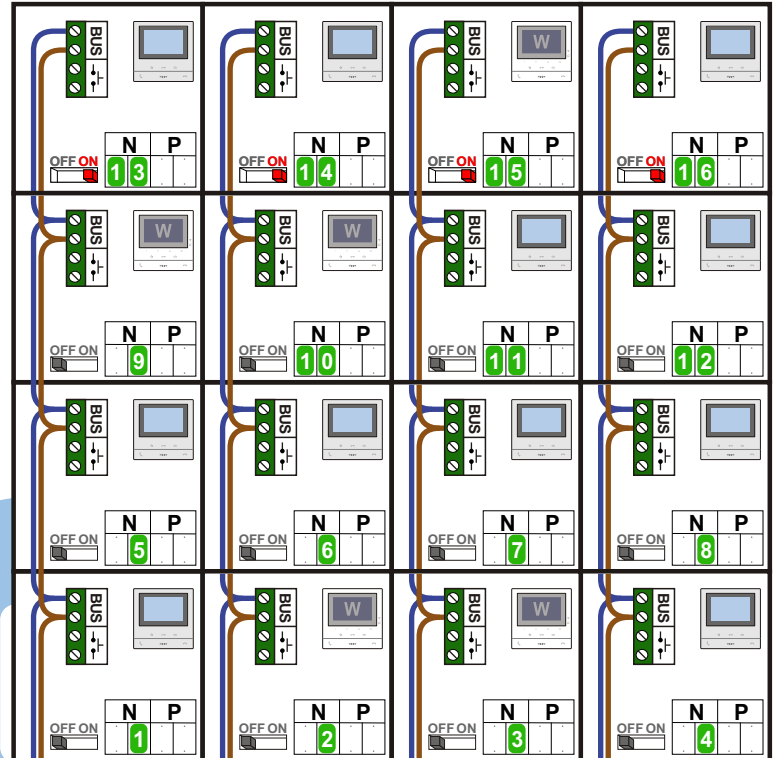

Haal de spanning van het systeem als je een module monteert of demonteert

DEURSTATION S-131V

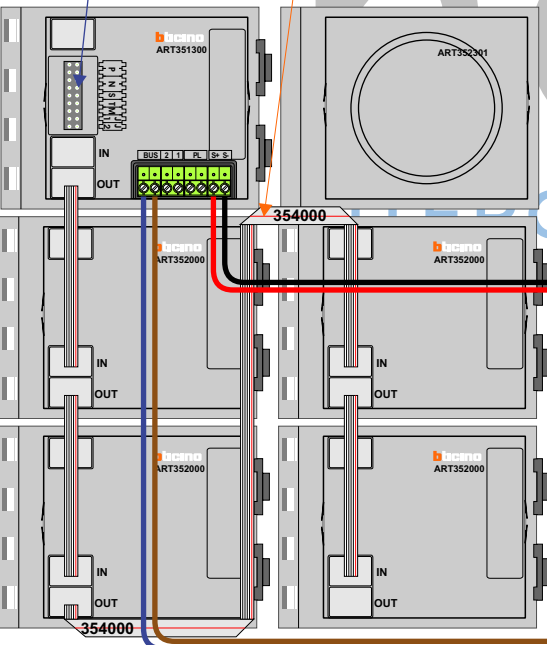

Pot.vrij contact tbv deur opener

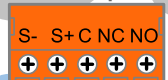

Max. 100 meter systeemkabel tot laatste videofoon

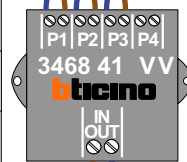
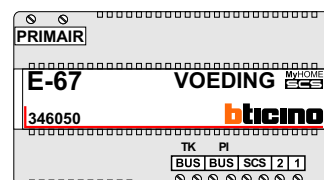

Max. 50 meter

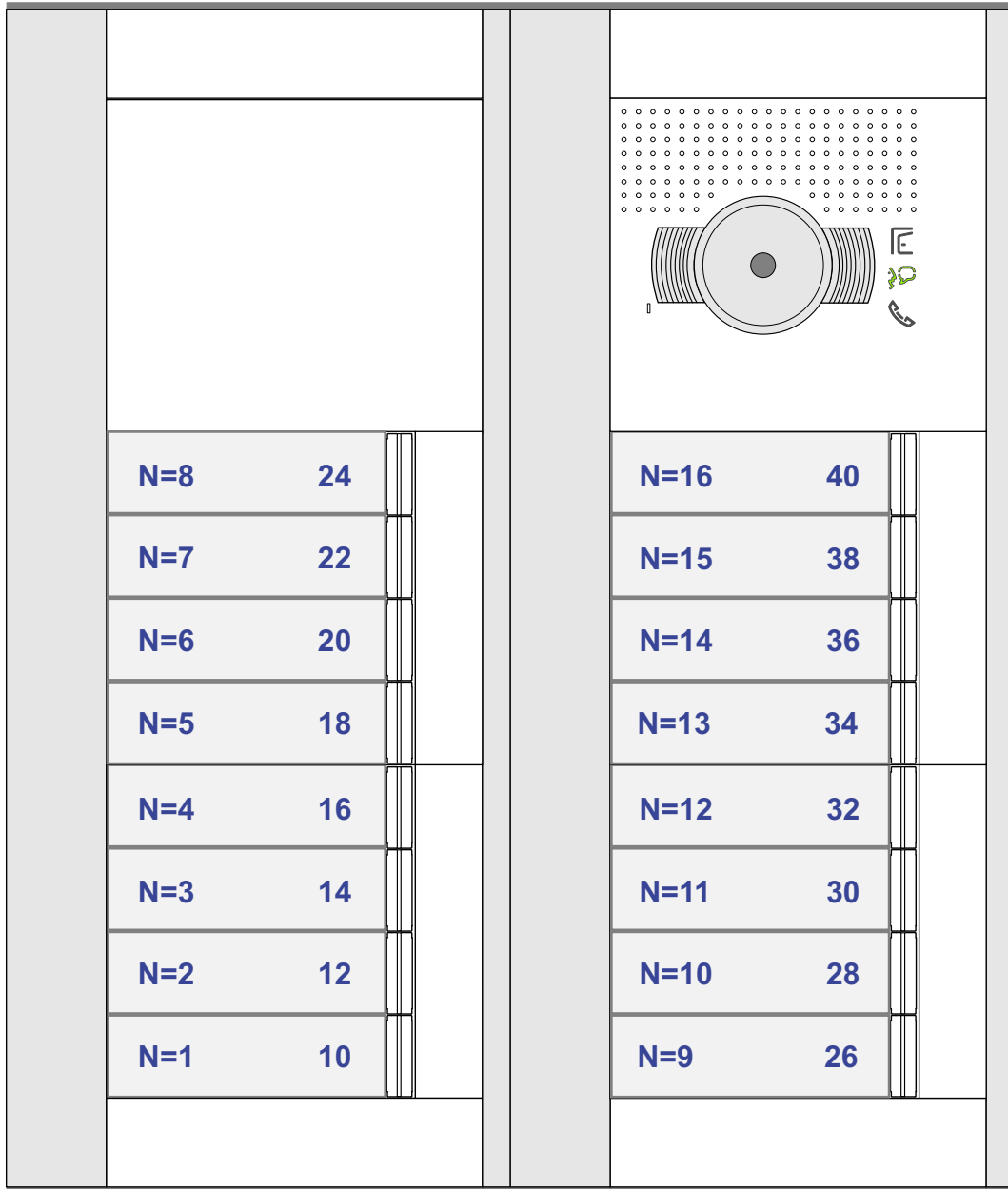

N-Waarde	Huisnummer	Switch-ON	Videofoon
1	10		M-50B
2	12		M-50W ifi
3	14		M-50W ifi
4	16		M-50B
5	18		M-50B
6	20		M-50B
7	22		M-50B
8	24		M-50B
9	26		M-50W ifi
10	28		M-50W ifi
11	30		M-50B
12	32		M-50B
13	34	X	M-50B
14	36	X	M-50B
15	38	X	M-50W ifi
16	40	X	M-50B

**— = systeemkabel**  
 Bij andere getwiste kabel 66% afstand!  
 Bij ongetwiste kabel max. 50 meter buitenpost naar videofoon.  
 UTP op aanvraag.

**TWEEDRAADS BUS**



Bij monteren/demonteren **spanning eraf** voorkomt defecten!

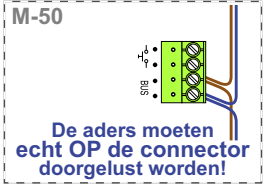

**Digitizers & flatcables**



Niet monteren/demonteren onder spanning  
 Beldrukkers mogen wel

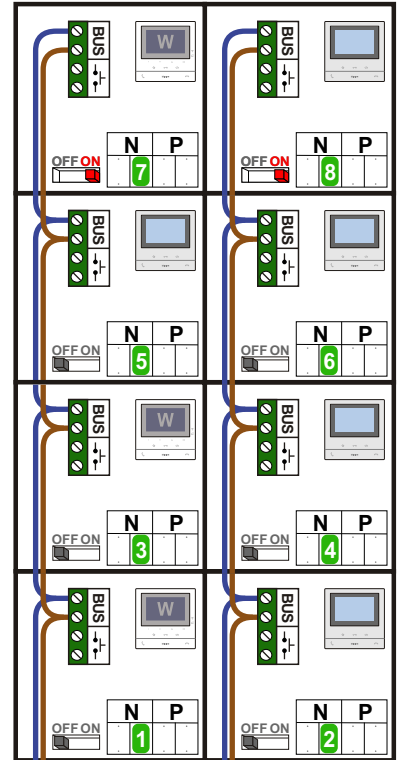

nelec  
INTERCOM MADE EASY

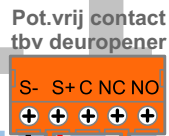
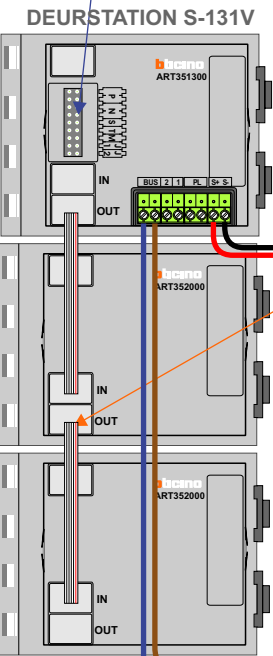
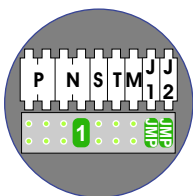

Haal de spanning van het systeem als je een module monteert of demonteert

Max. 100 meter systeemkabel tot laatste videofoon

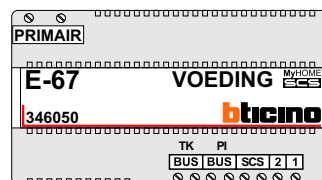

Max. 50 meter

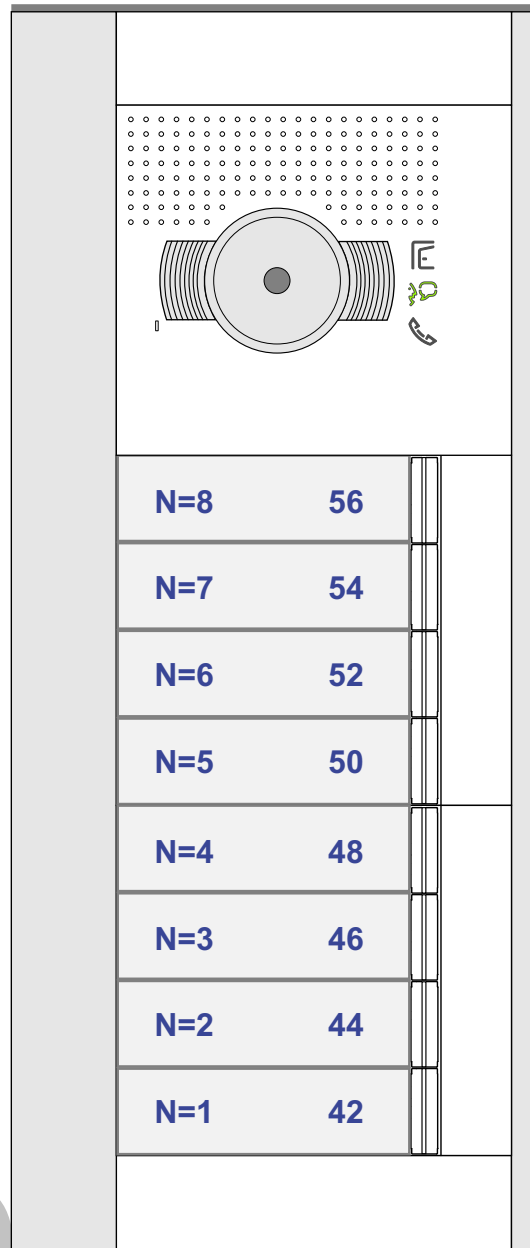

# nelec

## INTERCOM MADE EASY

N-Waarde	Huisnummer	Switch-ON	Videfoon
1	42		M-50W ifi
2	44		M-50B
3	46		M-50W ifi
4	48		M-50B
5	50		M-50B
6	52		M-50B
7	54	X	M-50W ifi
8	56	X	M-50B