



**TWEEDRAADS BUS**

Bij monteren/demonteren spanning eraf voorkomt defecten!

**DD8 digitizer: flatcable**



Connector van flatcable nokje juiste kant op bij aansluiten op DD8

**Digitizers & flatcables**



Niet monteren/demonteren onder spanning  
Beldrukkers mogen wel

**VideoVerdeler**

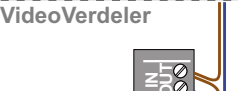

De aders moeten echt OP de klemmen doorgelust worden!

**M-50**

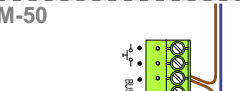

De aders moeten echt OP de connector doorgelust worden!

**346050**

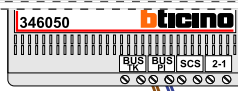

De twee stijgers echt OP de klemmen van E-67 aansluiten!

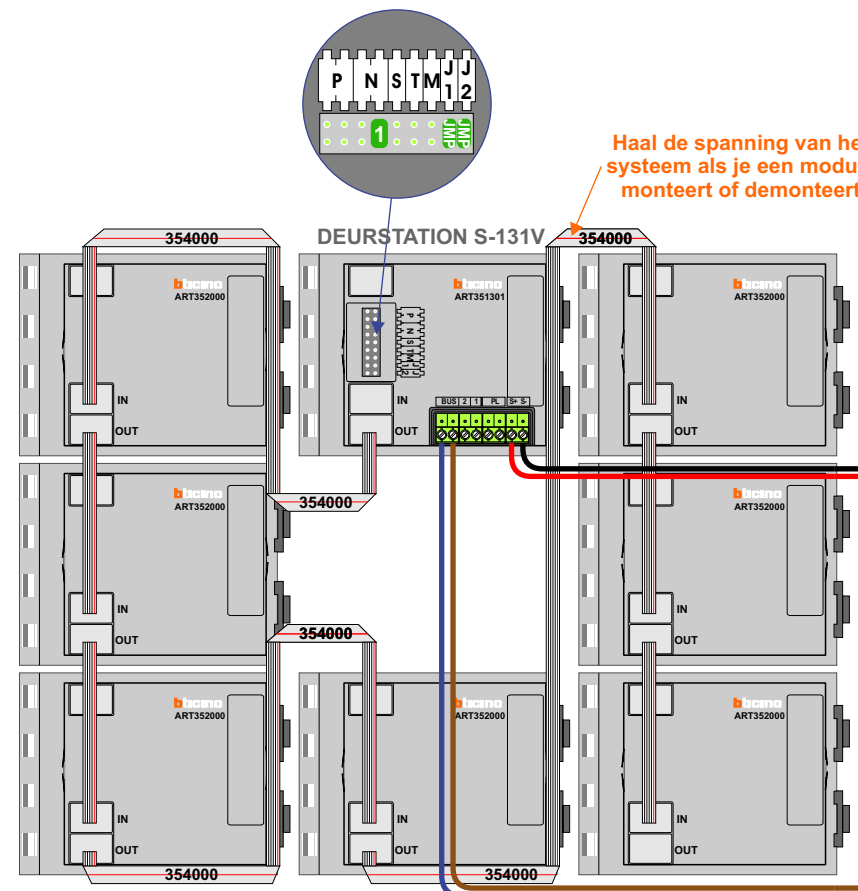
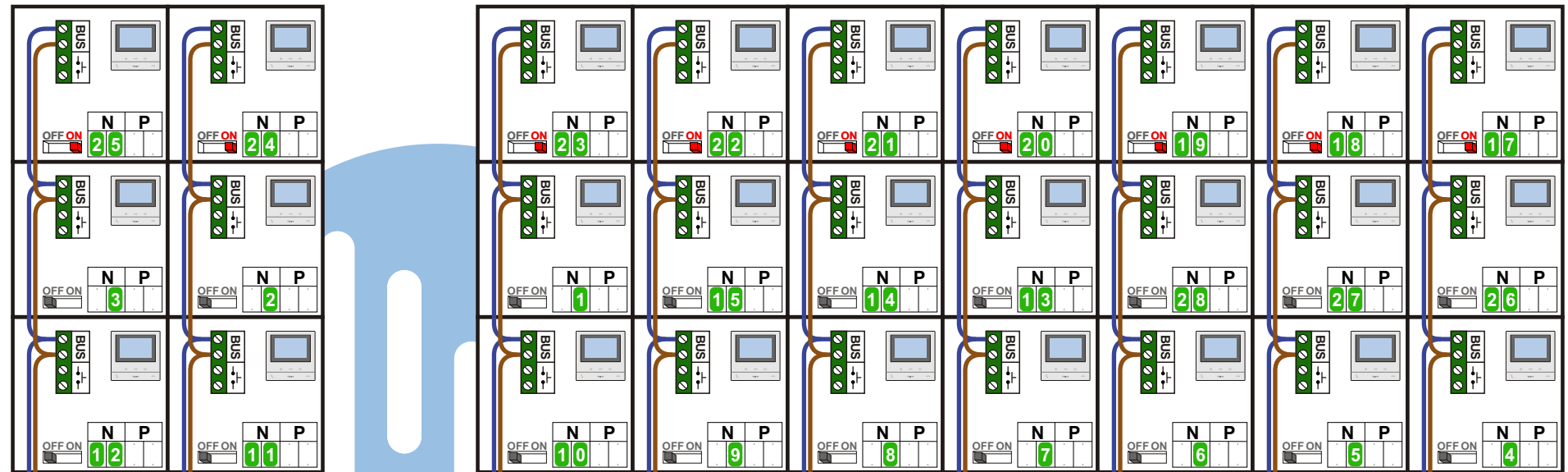

**nelec**  
INTERCOM MADE EASY

Pot.vrij contact tbv deuropener  
S- S+ C NC NO

Max. 100 meter systeemkabel tot laatste videofoon

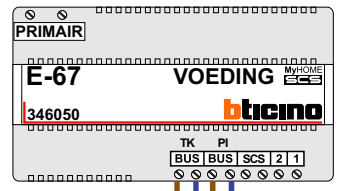

Max. 50 meter

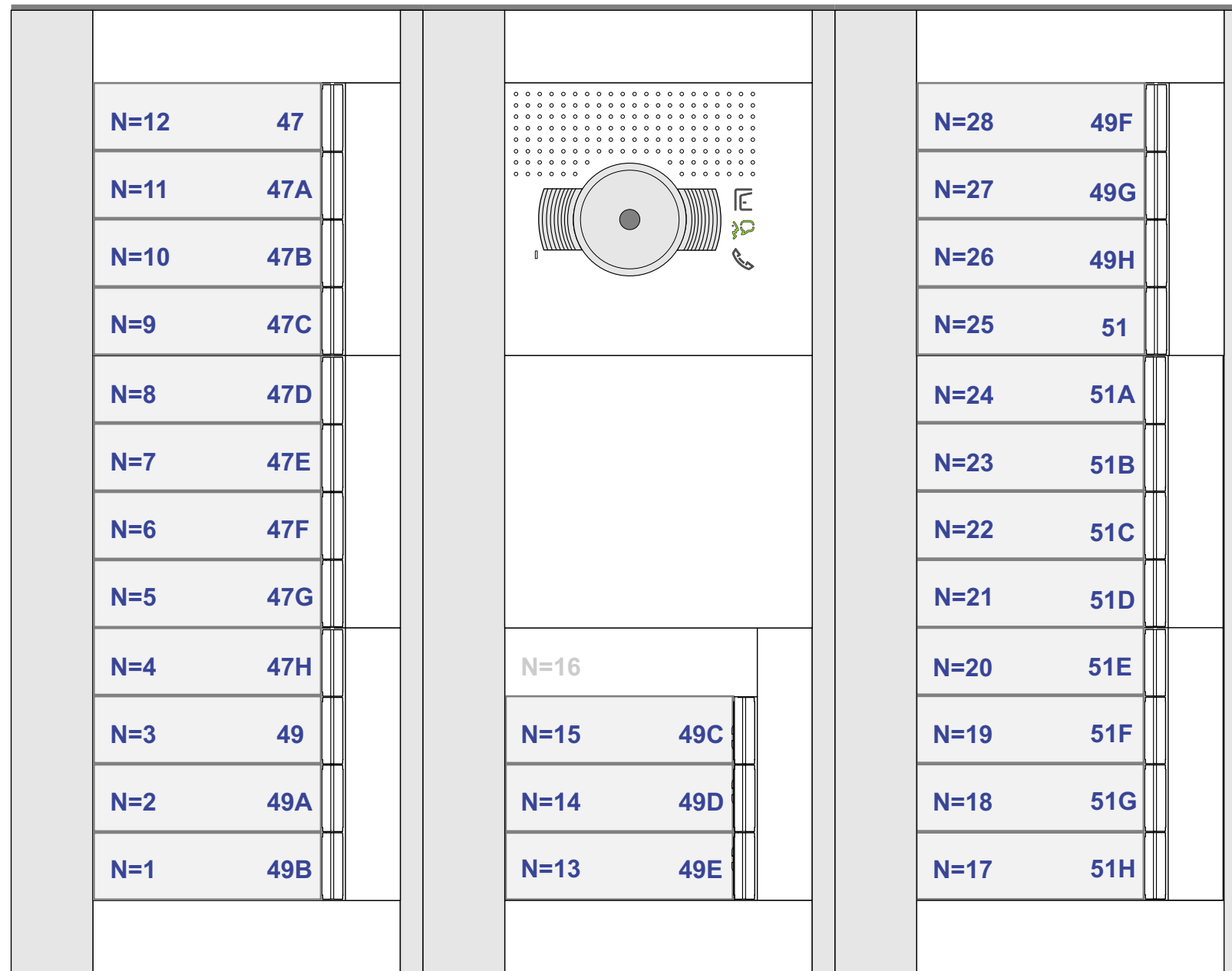

N-Waarde	Huisnummer	Switch-ON
1	49B	
2	49A	
3	49	
4	47H	
5	47G	
6	47F	
7	47E	
8	47D	
9	47C	
10	47B	
11	47A	
12	47	
13	49E	
14	49D	
15	49C	
16		
17	51H	X
18	51G	X
19	51F	X
20	51E	X
21	51D	X
22	51C	X
23	51B	X
24	51A	X
25	51	X
26	49H	
27	49G	
28	49F	

INTERCOM MADE EASY