

— = systeemkabel
Bij andere getwiste kabel **66%** afstand!
Bij ongetwiste kabel **max. 50 meter** buitenpost naar videofoon.
UTP op aanvraag.

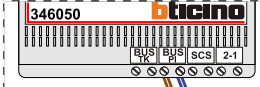

De twee stijgers **echt OP** de klemmen van E-67 aansluiten!



De aders moeten **echt OP** de klemmen doorgelust worden!

DD8 digitizer: flatcable



Digitizers & flatcables



TWEEDRAADS BUS



Bij monteren/demonteren **spanning eraf** voorkomt defecten!

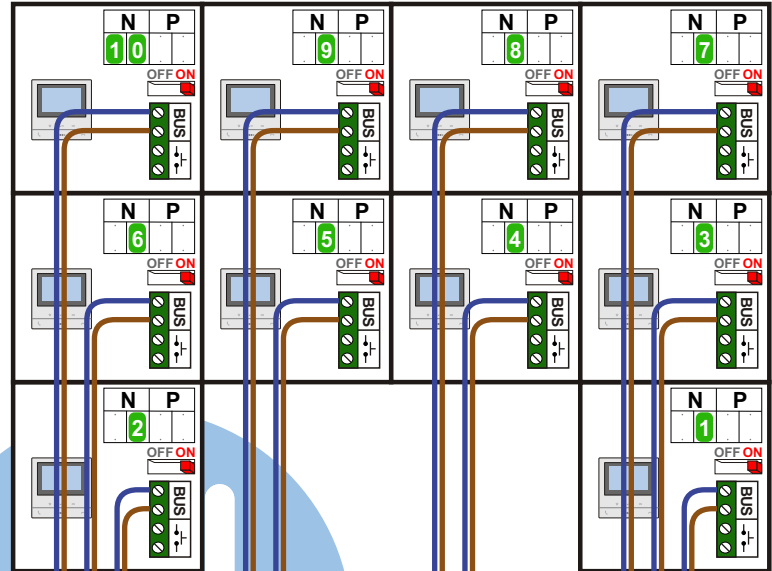

nelec

INTERCOM MADE EASY

Haal de spanning van het systeem als je een digitizer monteert of demonteert

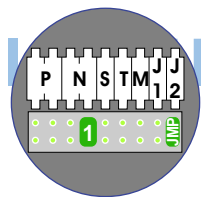

Pot.vrij contact tbv deuropener



DEURSTATION S-130V

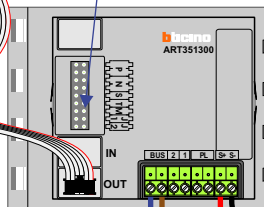

Digitizer voor 1 t/m 8 drukkers

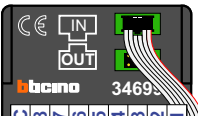

Digitizer voor 9 t/m 16 drukkers

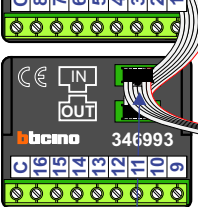

nokjes connectoren wijzen naar elkaar

Max. 50 meter

Max. 100 meter systeemkabel tot laatste videofoon

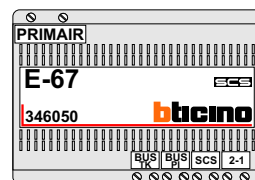

N-waarde	Huisnummer	Eindweerstand
1	30	X
2	32	X
3	34	X
4	36	X
5	38	X
6	40	X
7	42	X
8	44	X
9	46	X
10	48	X



nelec
INTERCOM MADE EASY