

TWEEDRAADS BUS



Bij monteren/demonteren spanning eraf voorkomt defecten!

= systeemkabel
Bij andere getwiste kabel 66% afstand!
Bij ongetwiste kabel max. 50 meter buitenpost naar videofoon.
UTP op aanvraag.

Digitizers & flatcables



Niet monteren/demonteren onder spanning
Beldrukkers mogen wel

DD8 digitizer: flatcable



Connector van flatcable nokje juiste kant op bij aansluiten op DD8

VideoVerdeler



De aders moeten echt OP de klemmen doorgelust worden!

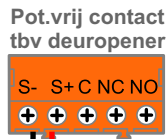
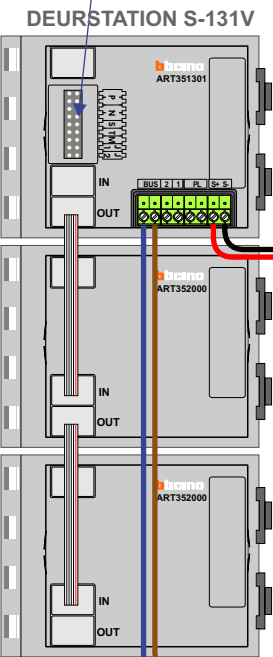
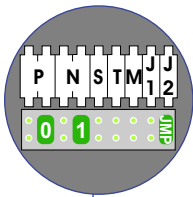

Max. 50 meter

Haal de spanning van het systeem als je een digitizer monteert of demonteert

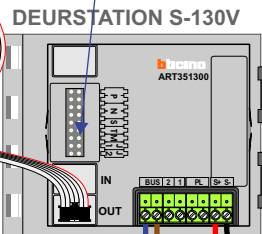
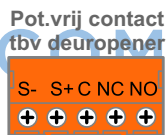
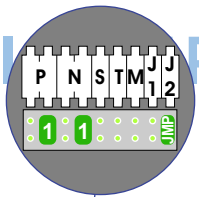

Digitizer voor 1 t/m 8 drukkers

Digitizer voor 9 t/m 16 drukkers

nokjes connectoren wijzen naar elkaar

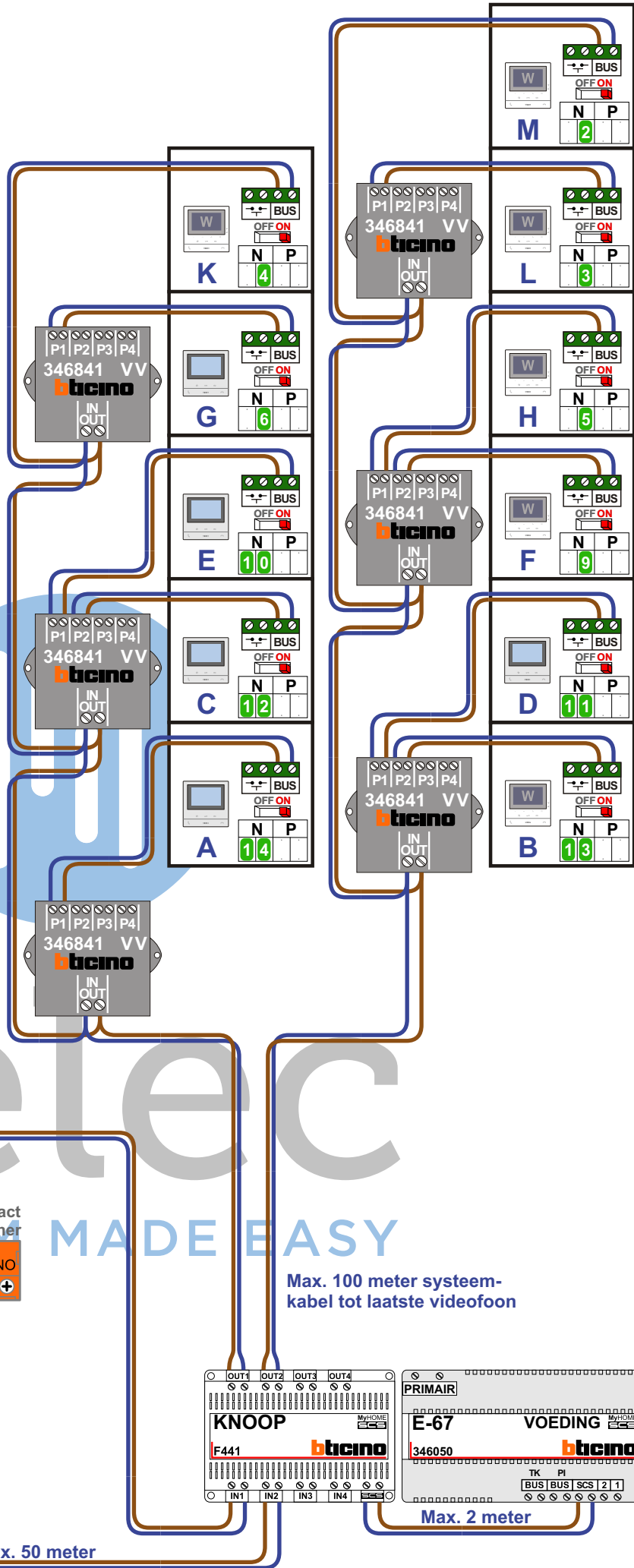

Max. 100 meter systeemkabel tot laatste videofoon

Max. 50 meter

Max. 2 meter

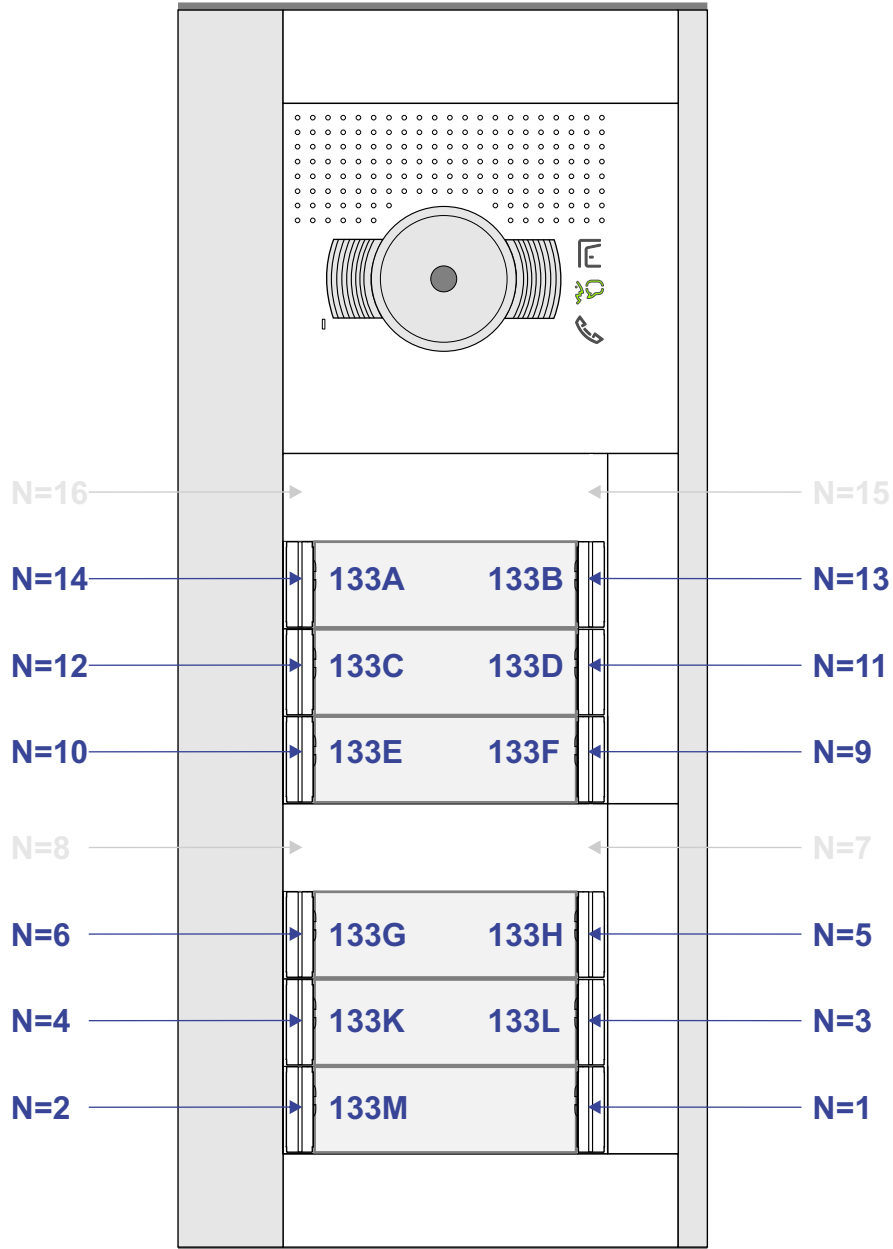

nelec

N-Waarde	Huisnummer	Switch-ON	Videfoon
1			
2	133M	X	M-50W ifi
3	133L	X	M-50W ifi
4	133K	X	M-50W ifi
5	133H	X	M-50W ifi
6	133G	X	M-50B
7			
8			
9	133F	X	M-50W ifi
10	133E	X	M-50B
11	133D	X	M-50B
12	133C	X	M-50B
13	133B	X	M-50W ifi
14	133A	X	M-50B
15			
16			