

— = systeemkabel
 Bij andere getwiste kabel 66% afstand!
 Bij ongetwiste kabel max. 50 meter buitenpost naar videofoon.
 UTP op aanvraag.

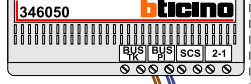

De twee stijgers echt OP de klemmen van E-67 aansluiten!

TWEEDRAADS BUS



Bij monteren/demonteren spanning eraf voorkomt defecten!

M-50



De aders moeten echt OP de connector doorgelust worden!

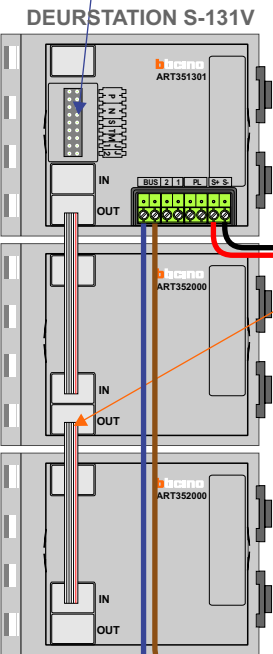
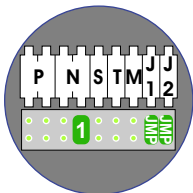

Pot.vrij contact
tbv deuropener



Haal de spanning van het systeem als je een module monteert of demonteert

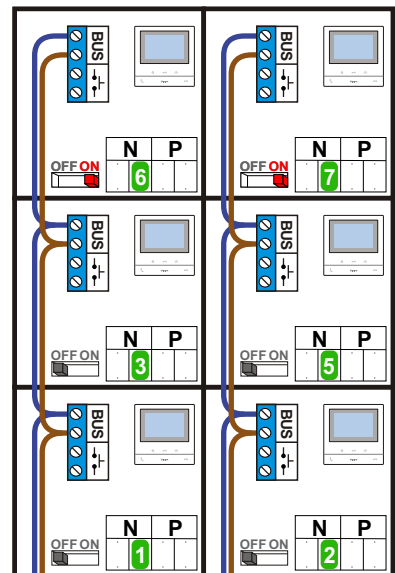

Max. 100 meter systeemkabel tot laatste videofoon

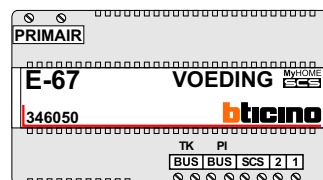

Max. 50 meter

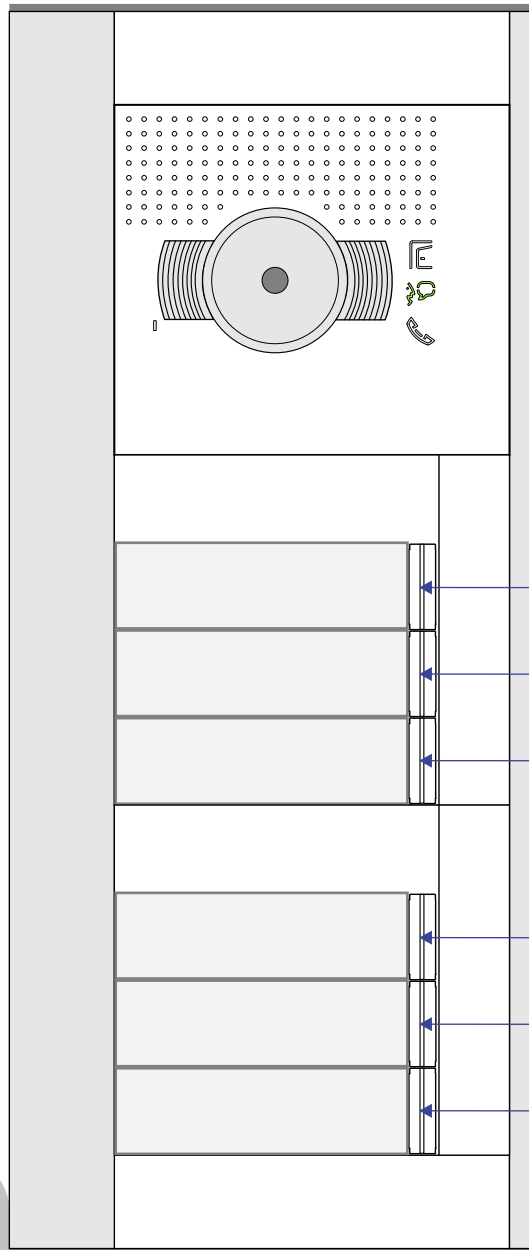

nelec
INTERCOM MADE EASY

N-Waarde	Huisnummer	Switch-ON
1	74	
2	76	
3	78	
5	80	
6	82	X
7	84	X