

— = systeemkabel
Bij andere getwiste kabel 66% afstand!
Bij ongetwiste kabel max. 50 meter buitenpost naar videofoon.
UTP op aanvraag.

DD8 digitizer: flatcable



Connector van flatcable nokje juiste kant op bij aansluiten op DD8

Digitizers & flatcables



Niet monteren/demonteren onder spanning
Beldrukkers mogen wel

M-50 / T-50

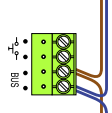

De aders moeten echt OP de connector doorgelust worden!

VideoVerdeler



De aders moeten echt OP de klemmen doorgelust worden!

TWEEDRAADS BUS



Bij monteren/demonteren spanning eraf voorkomt defecten!

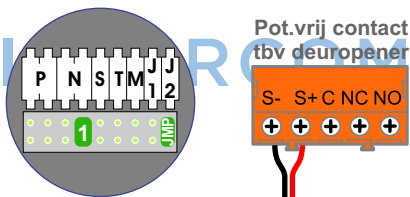
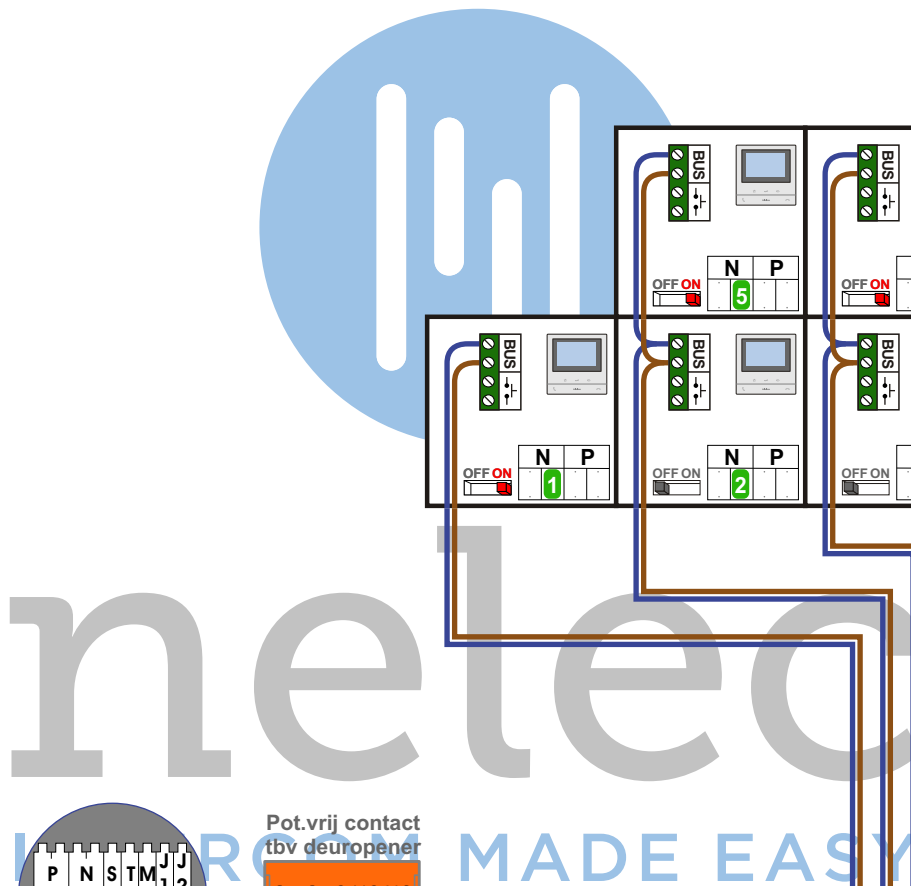
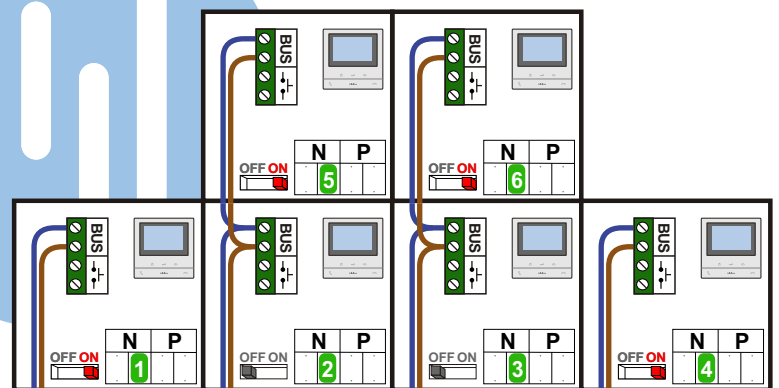

Haal de spanning van het systeem als je de digitizer monteert of demonteert

DEURSTATION S-130V

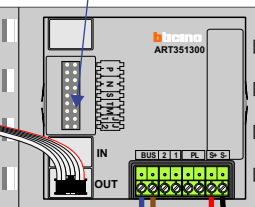

Digitizer voor 1 t/m 8 drukkers

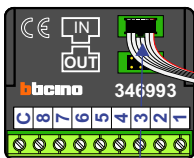

nokjes connectoren wijzen naar elkaar

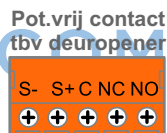

Max. 100 meter systeemkabel tot laatste videofoon

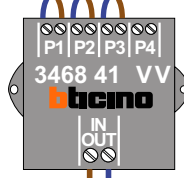
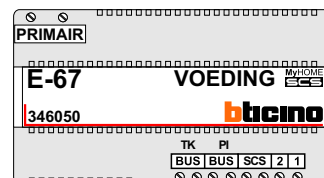

Max. 50 meter