



— = systeemkabel
 Bij andere getwiste kabel 66% afstand!
 Bij ongetwiste kabel max. 50 meter buitenpost naar videofoon.
 UTP op aanvraag.

DD8 digitizer: flatcable

 Connector van flatcable nokje juiste kant op bij aansluiten op DD8

Digitizers & flatcables

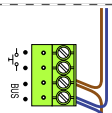
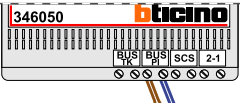
 Niet monteren/demonteren onder spanning
 Beldrukkers mogen wel

M-50

 De aders moeten echt OP de connector doorgelust worden!

346050 bticino

 De twee stijgers echt OP de klemmen van E-67 aansluiten!

TWEEDRAADS BUS



Bij monteren/demonteren spanning eraf voorkomt defecten!



nelec
INTERCOM MADE EASY

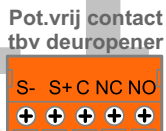
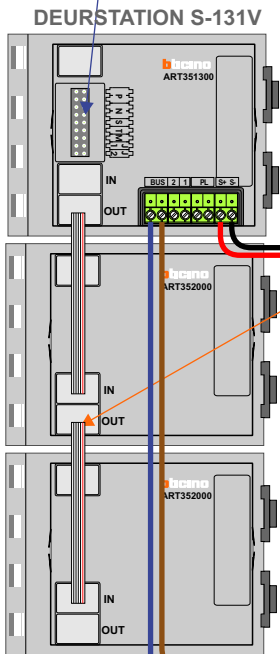
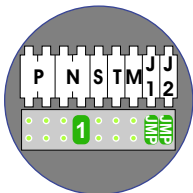
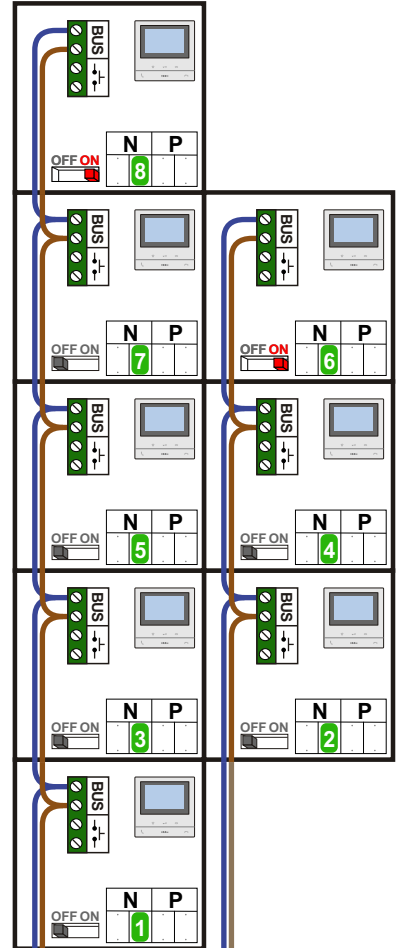

Haal de spanning van het systeem als je een module monteert of demonteert

Max. 100 meter systeemkabel tot laatste videofoon

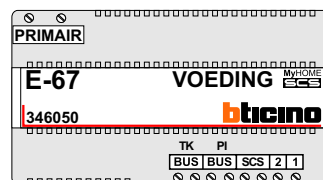

Max. 50 meter

— = systeemkabel
Bij andere getwiste kabel 66% afstand!
Bij ongetwiste kabel max. 50 meter buitenpost naar videofoon.
UTP op aanvraag.

TWEEDRAADS BUS
 
Bij monteren/demonteren spanning eraf voorkomt defecten!

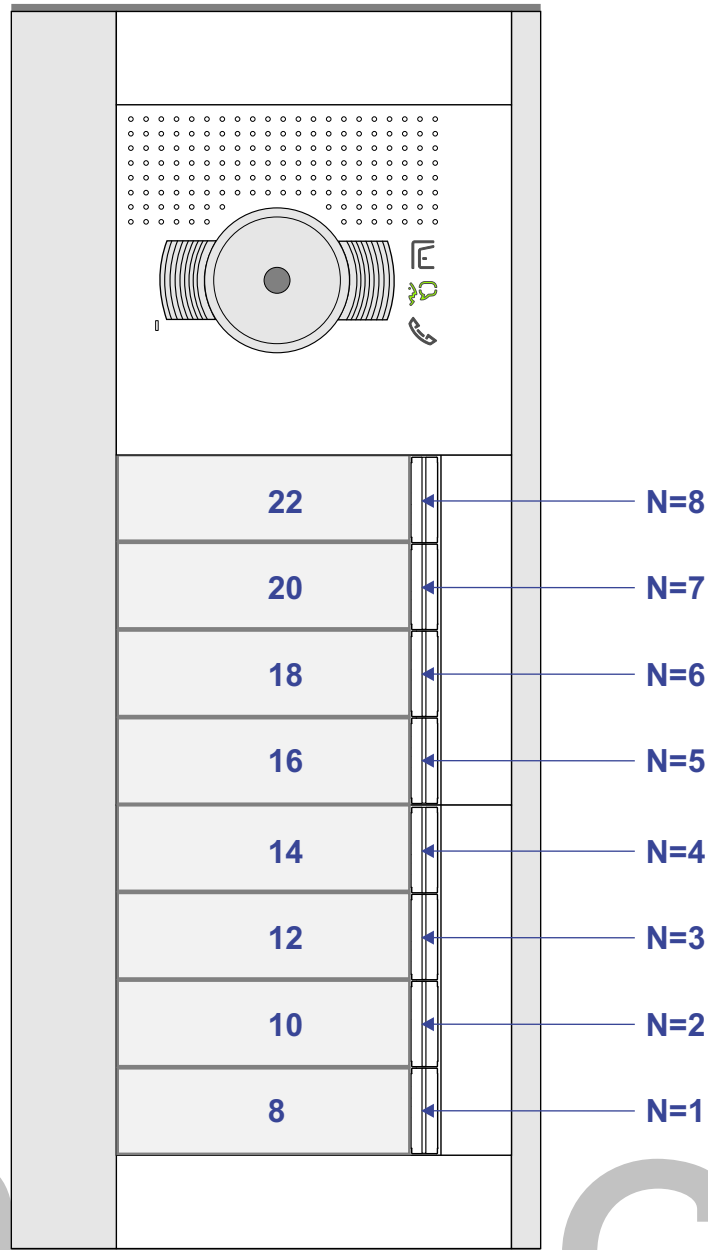

nelec

INTERCOM MADE EASY

N-Waarde	Huisnummer	Switch-ON
1	8	
2	10	
3	12	
4	14	
5	16	
6	18	X
7	20	
8	22	X

— = systeemkabel
Bij andere getwiste kabel 66% afstand!
Bij ongetwiste kabel max. 50 meter buitenpost naar videofoon.
UTP op aanvraag.



Digitizers & flatcables

Niet monteren/demonteren onder spanning
Beldrukkers mogen wel

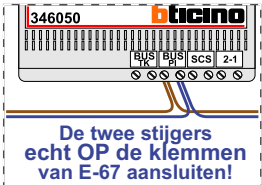
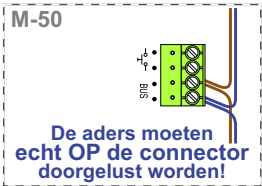

TWEEDRAADS BUS



Bij monteren/demonteren spanning eraf voorkomt defecten!

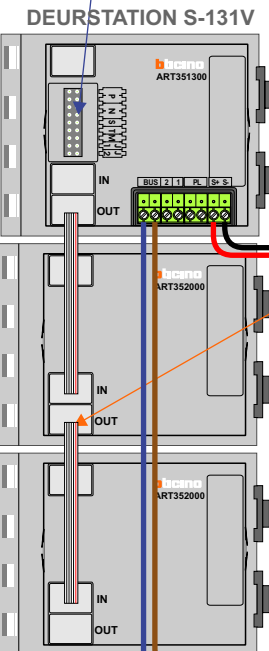
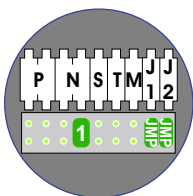
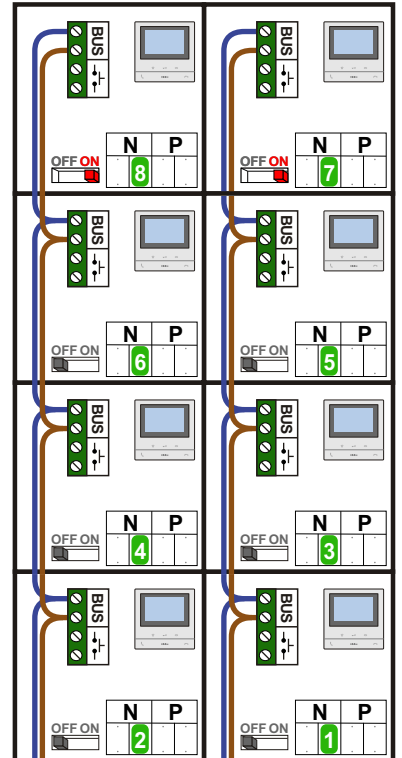

Pot.vrij contact tbv deuropener

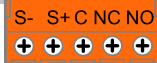

Haal de spanning van het systeem als je een module monteert of demonteert

Max. 100 meter systeemkabel tot laatste videofoon

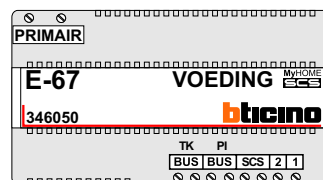

Max. 50 meter

— = systeemkabel
Bij andere getwiste kabel 66% afstand!
Bij ongetwiste kabel max. 50 meter buitenpost naar videofoon.
UTP op aanvraag.

TWEEDRAADS BUS



Bij monteren/demonteren spanning eraf voorkomt defecten!

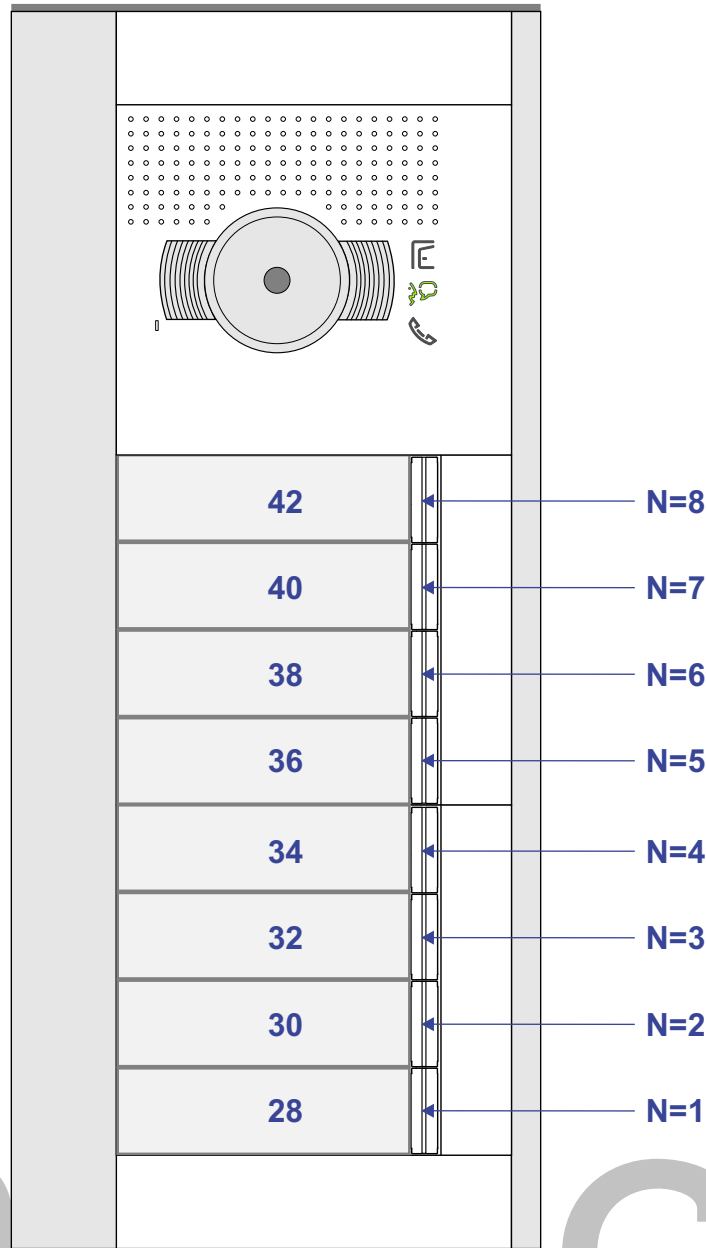

nelec

INTERCOM MADE EASY

N-Waarde	Huisnummer	Switch-ON
1	28	
2	30	
3	32	
4	34	
5	36	
6	38	
7	40	X
8	42	X

— = systeemkabel
 Bij andere getwiste kabel 66% afstand!
 Bij ongetwiste kabel max. 50 meter buitenpost naar videofoon.
 UTP op aanvraag.



Digitizers & flatcables

Niet monteren/demonteren onder spanning
 Beldrukkers mogen wel

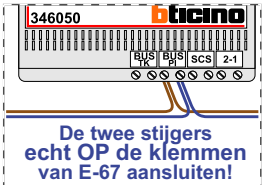
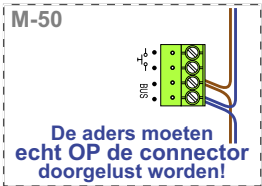

TWEEDRAADS BUS

Bij monteren/demonteren spanning eraf voorkomt defecten!



nelec
INTERCOM MADE EASY

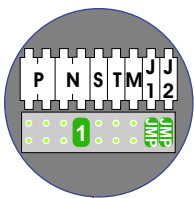
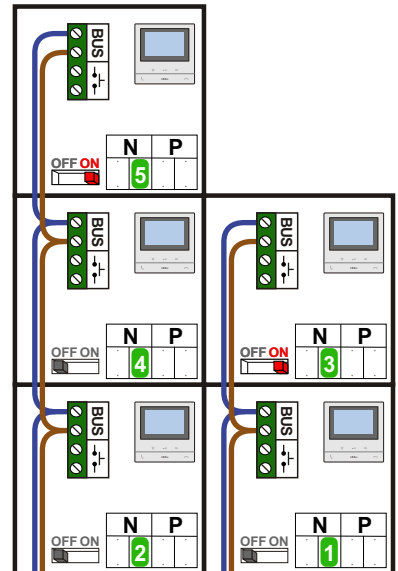

Haal de spanning van het systeem als je een module monteert of demonteert

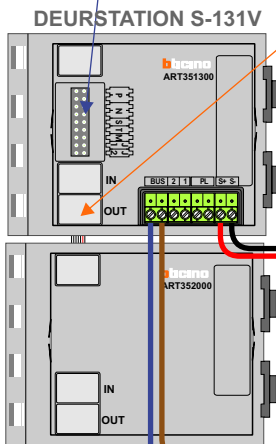

Max. 100 meter systeemkabel tot laatste videofoon

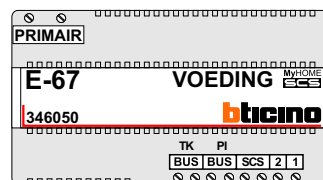

Max. 50 meter

 = systeemkabel
 Bij andere getwiste kabel 66% afstand!
 Bij ongetwiste kabel max. 50 meter buitenpost naar videofoon.
 UTP op aanvraag.

TWEEDRAADS BUS
 
 Bij monteren/demonteren spanning eraf voorkomt defecten!

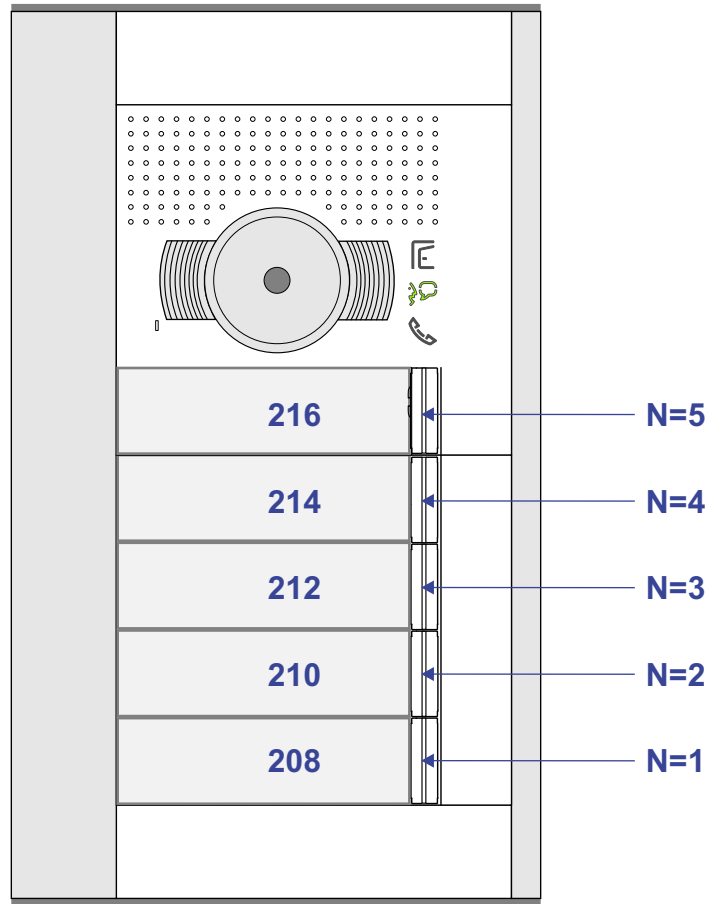

nelec

INTERCOM MADE EASY

N-Waarde	Huisnummer	Switch-ON
1	208	
2	210	
3	212	X
4	214	
5	216	X

— = systeemkabel
Bij andere getwiste kabel 66% afstand!
Bij ongetwiste kabel max. 50 meter buitenpost naar videofoon.
UTP op aanvraag.



Digitizers & flatcables

Niet monteren/demonteren onder spanning
Beldrukkers mogen wel

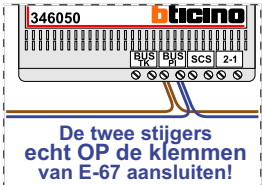
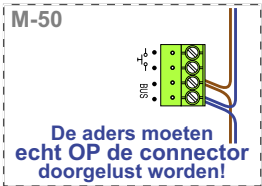

TWEEDRAADS BUS

Bij monteren/demonteren spanning eraf voorkomt defecten!



nelec
INTERCOM MADE EASY

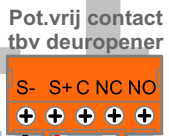
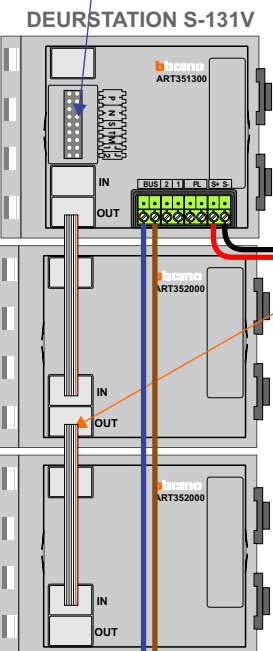
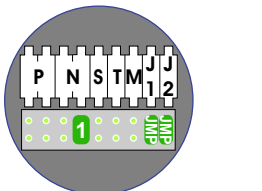

Haal de spanning van het systeem als je een module monteert of demonteert

Max. 100 meter systeemkabel tot laatste videofoon

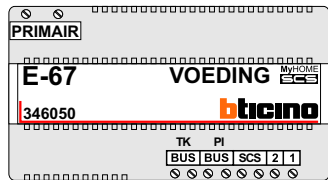

Max. 50 meter

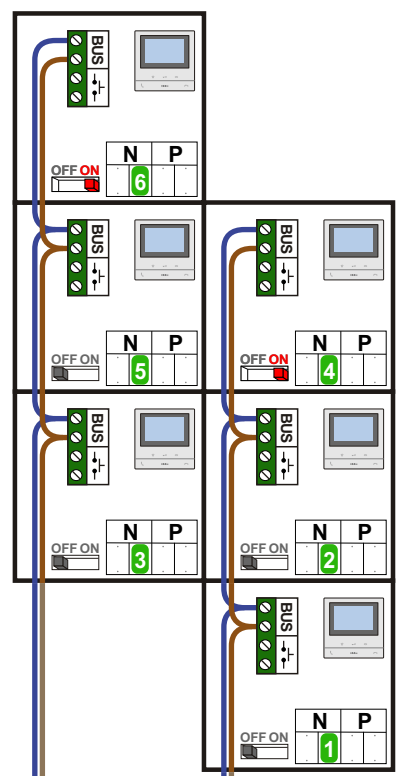

— = systeemkabel
Bij andere getwiste kabel 66% afstand!
Bij ongetwiste kabel max. 50 meter buitenpost naar videofoon.
UTP op aanvraag.

TWEEDRAADS BUS
 
Bij monteren/demonteren spanning eraf voorkomt defecten!

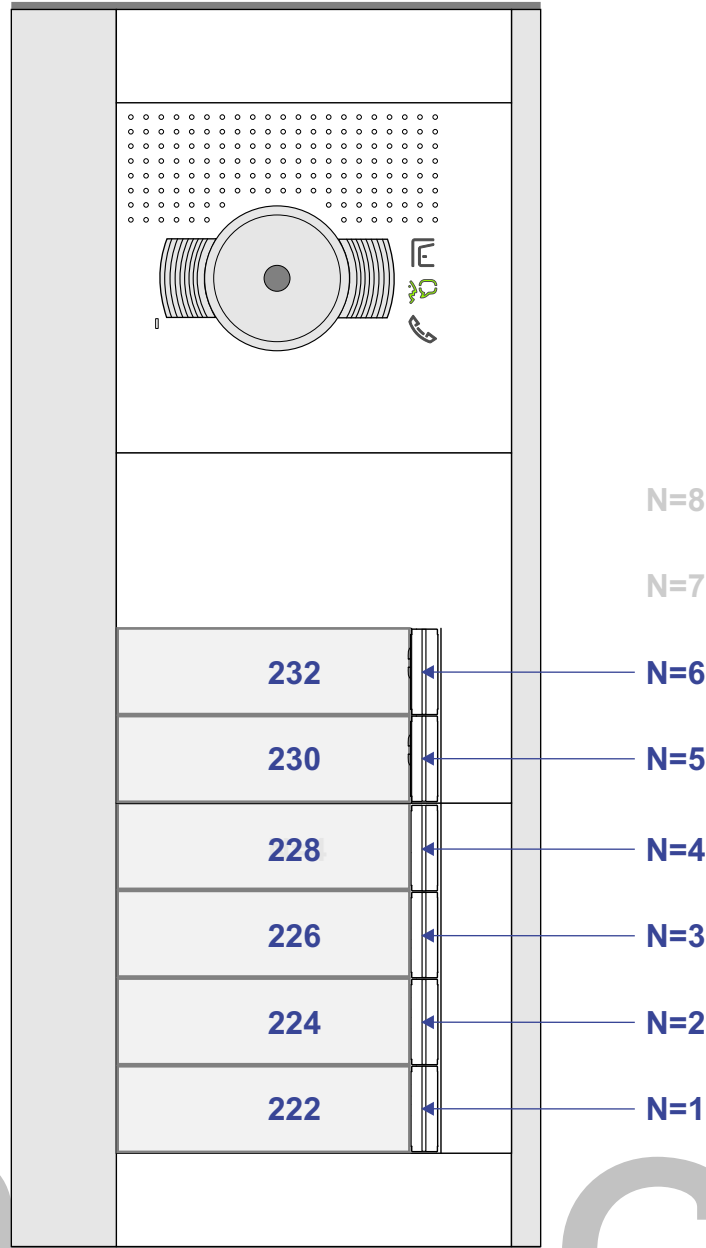

nelec

INTERCOM MADE EASY

N-Waarde	Huisnummer	Switch-ON
1	222	
2	224	
3	226	
4	228	X
5	230	
6	232	X