

**— = systeemkabel**  
Bij andere getwiste kabel **66%** afstand!  
Bij ongetwiste kabel **max. 50 meter** buitenpost naar videofoon.  
UTP op aanvraag.

**TWEEDRAADS BUS**



Bij monteren/demonteren **spanning eraf** voorkomt defecten!

**M-50**  
De aders moeten echt **OP** de connector doorgelust worden!

**VideoVerdeler**  
De aders moeten echt **OP** de klemmen doorgelust worden!

**M-50e M-50W**  
Bij hulpvoeding op 1-2: zet switch op **ON**

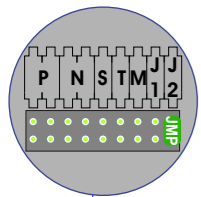

BUITENPOST S-140V

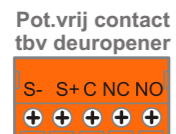
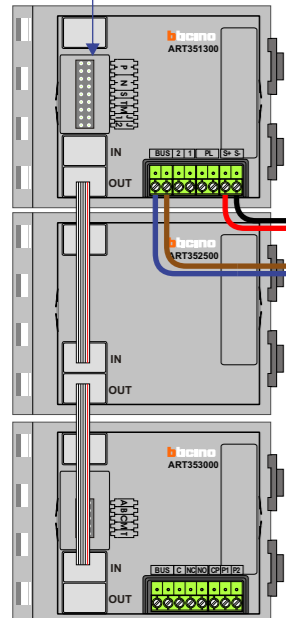

Pot.vrij contact tbv deuropener

Max. 50 meter

Hulpvoeding

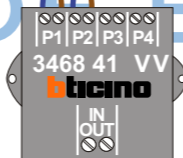
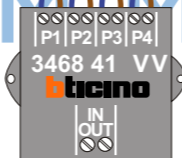
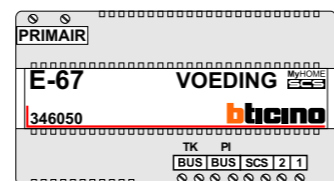

Hulpvoeding

Max. 100 meter systeemkabel tot laatste videofoon

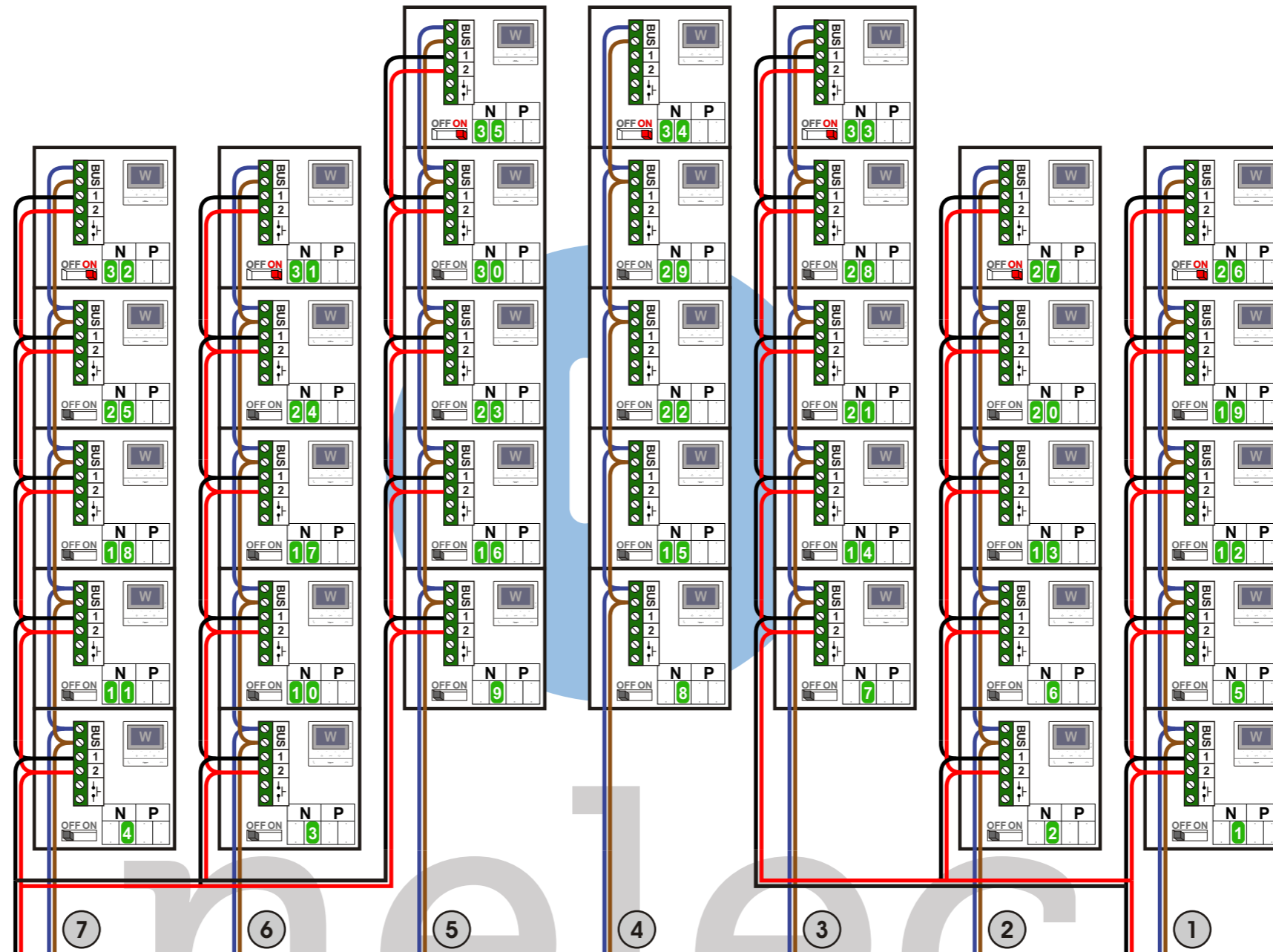

INTERCOM MADE EASY

N-waarde	Huisnummer	Eindweerstand
1	1	
2	3	
3	5	
4	7	
5	9	
6	11	
7	13	
8	15	
9	17	
10	19	
11	21	
12	23	
13	25	
14	27	
15	29	
16	31	
17	33	
18	35	
19	37	
20	39	
21	41	
22	43	
23	45	
24	47	
25	49	
26	51	X
27	53	X
28	55	
29	57	
30	59	
31	61	X
32	63	X
33	65	X
34	67	X
35	69	X

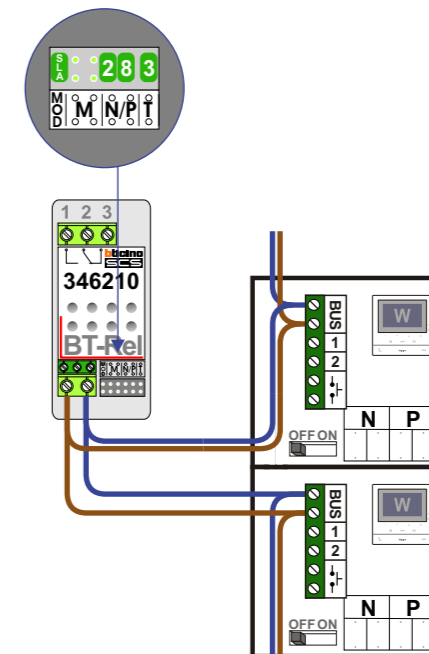

Aansluiten BT-relais

nelec  
INTERCOM MADE EASY