

**— = systeemkabel**  
Bij andere getwiste kabel 66% afstand!  
Bij ongetwiste kabel max. 50 meter buitenpost naar videofoon.  
UTP op aanvraag.

**TWEEDRAADS BUS**

   
Bij monteren/demonteren spanning eraf voorkomt defecten!

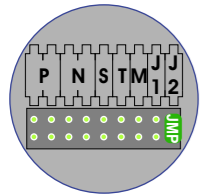

DEURSTATION S-140V

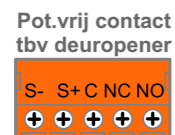
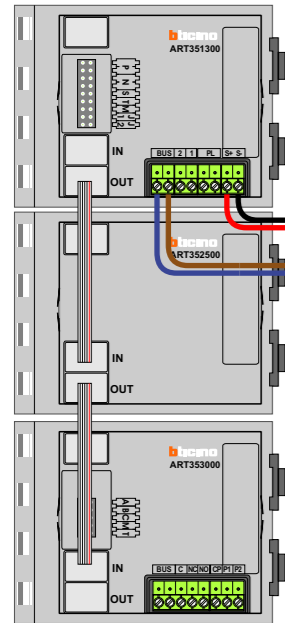

Max. 50 meter

naar VV pagina 2

naar VV pagina 5

Max. 100 meter systeemkabel tot laatste videofoon

naar VV pagina 3

naar VV pagina 4

Max. 100 meter systeemkabel tot laatste videofoon

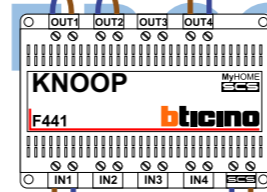

KNOOP 1

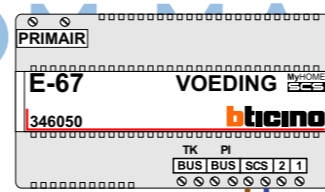

Max. 2 meter

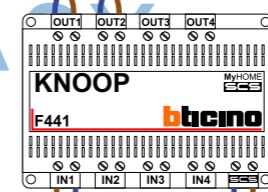
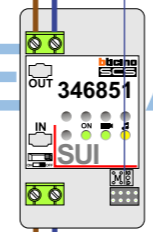
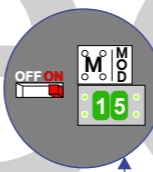

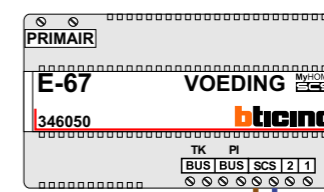

KNOOP 2



Max. 2 meter

**TWEEDRAADS BUS**

 

Bij monteren/demonteren spanning eraf voorkomt defecten!

**M-50e M-50W**  
Bij hulpvoeding op 1-2: zet switch op ON

 2-1  
ON OFF

**VideoVerdeler**



De aders moeten echt OP de klemmen doorgelust worden!



**M-50**

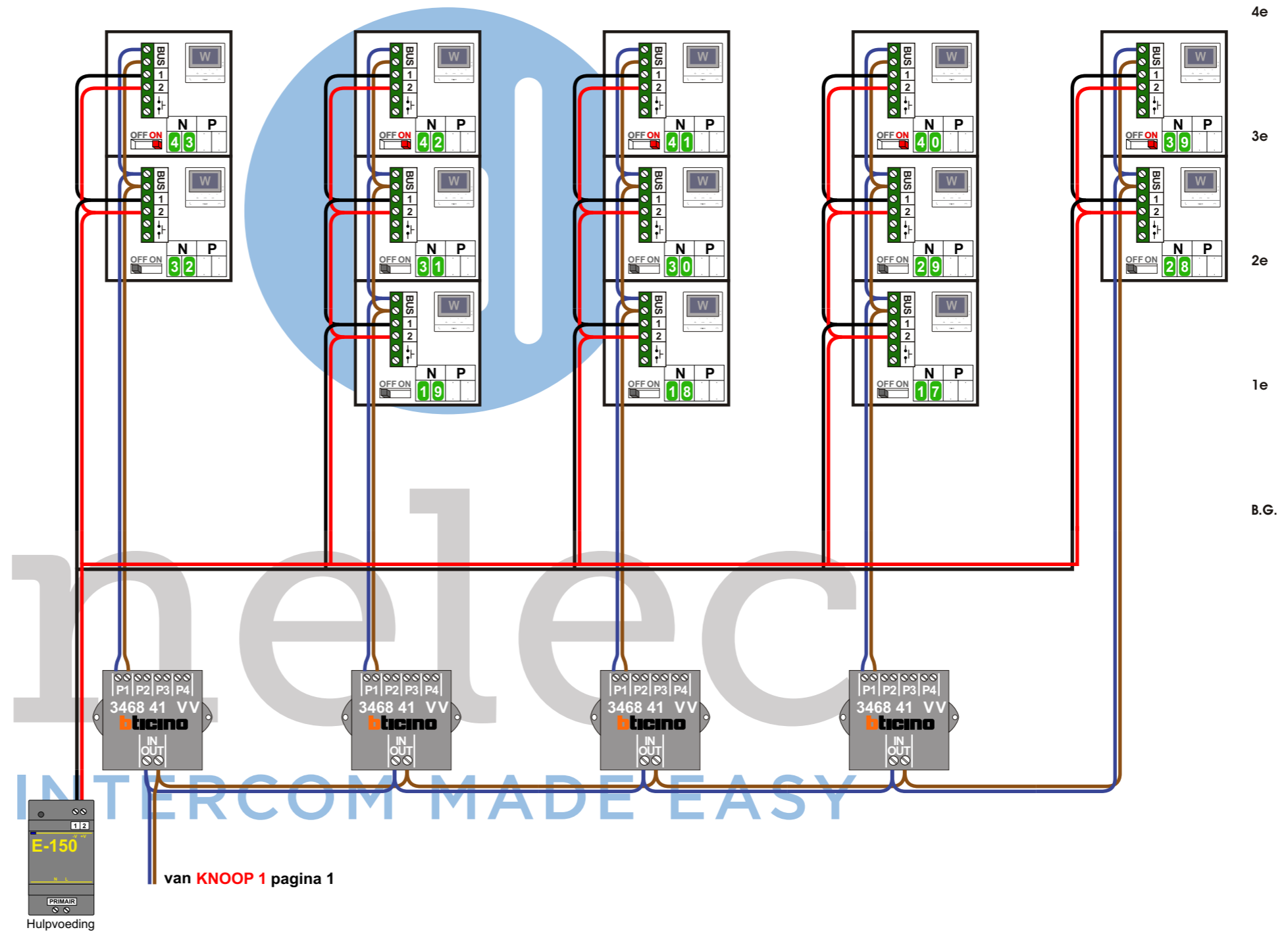

De aders moeten echt OP de connector doorgelust worden!



**TWEEDRAADS BUS**

 

Bij monteren/demonteren spanning eraf voorkomt defecten!

**M-50e M-50W**  
Bij hulpvoeding op 1-2: zet switch op ON

 2-1  
ON OFF

**VideoVerdeler**



De aders moeten echt OP de klemmen doorgelust worden!

**M-50**



De aders moeten echt OP de connector doorgelust worden!

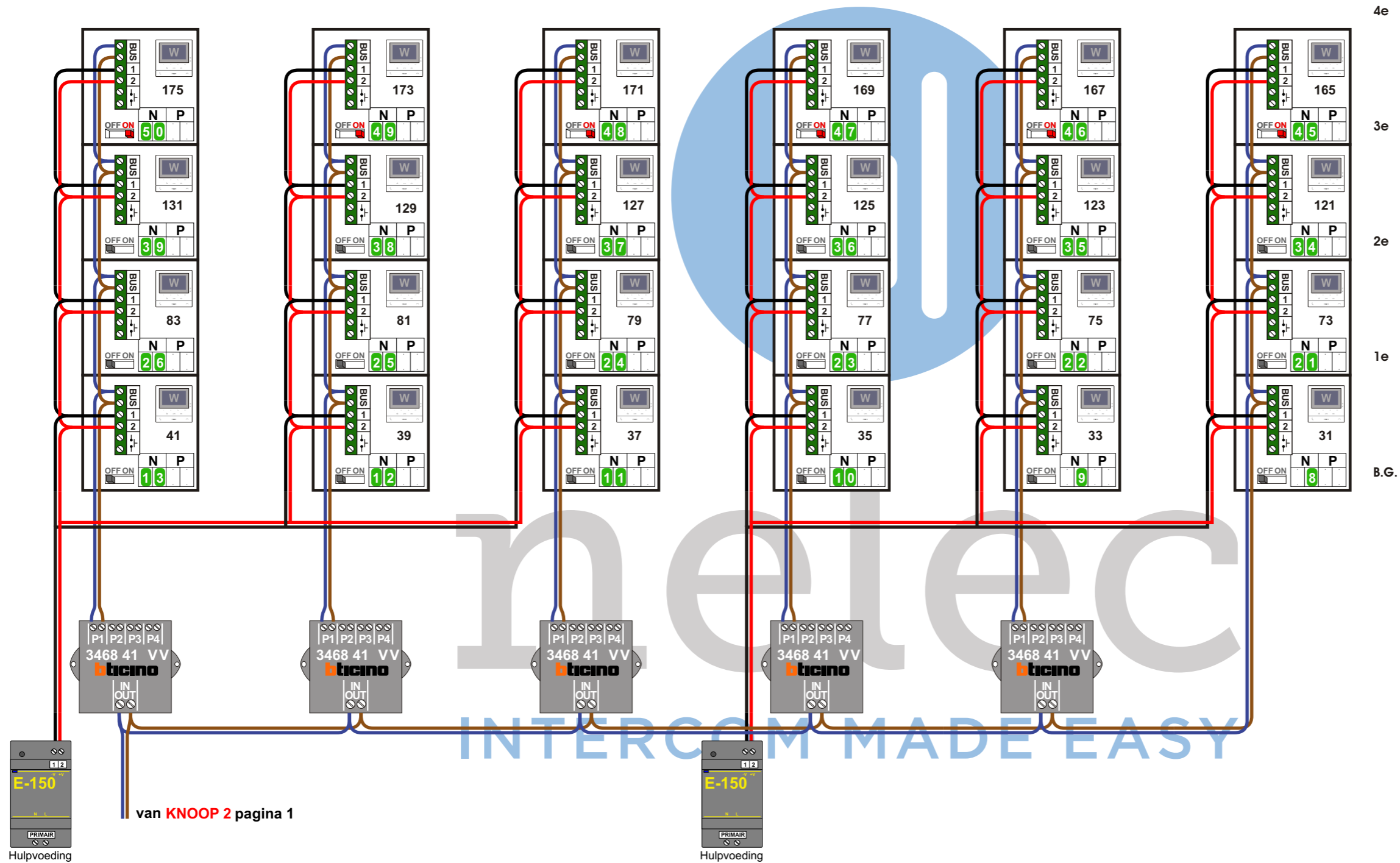

**TWEEDRAADS BUS**

Bij monteren/demonteren spanning eraf voorkomt defecten!

**M-50e M-50W**  
Bij hulpvoeding op 1-2: zet switch op ON

ON OFF

**VideoVerdeler**



De aders moeten echt OP de klemmen doorgelust worden!

**M-50**

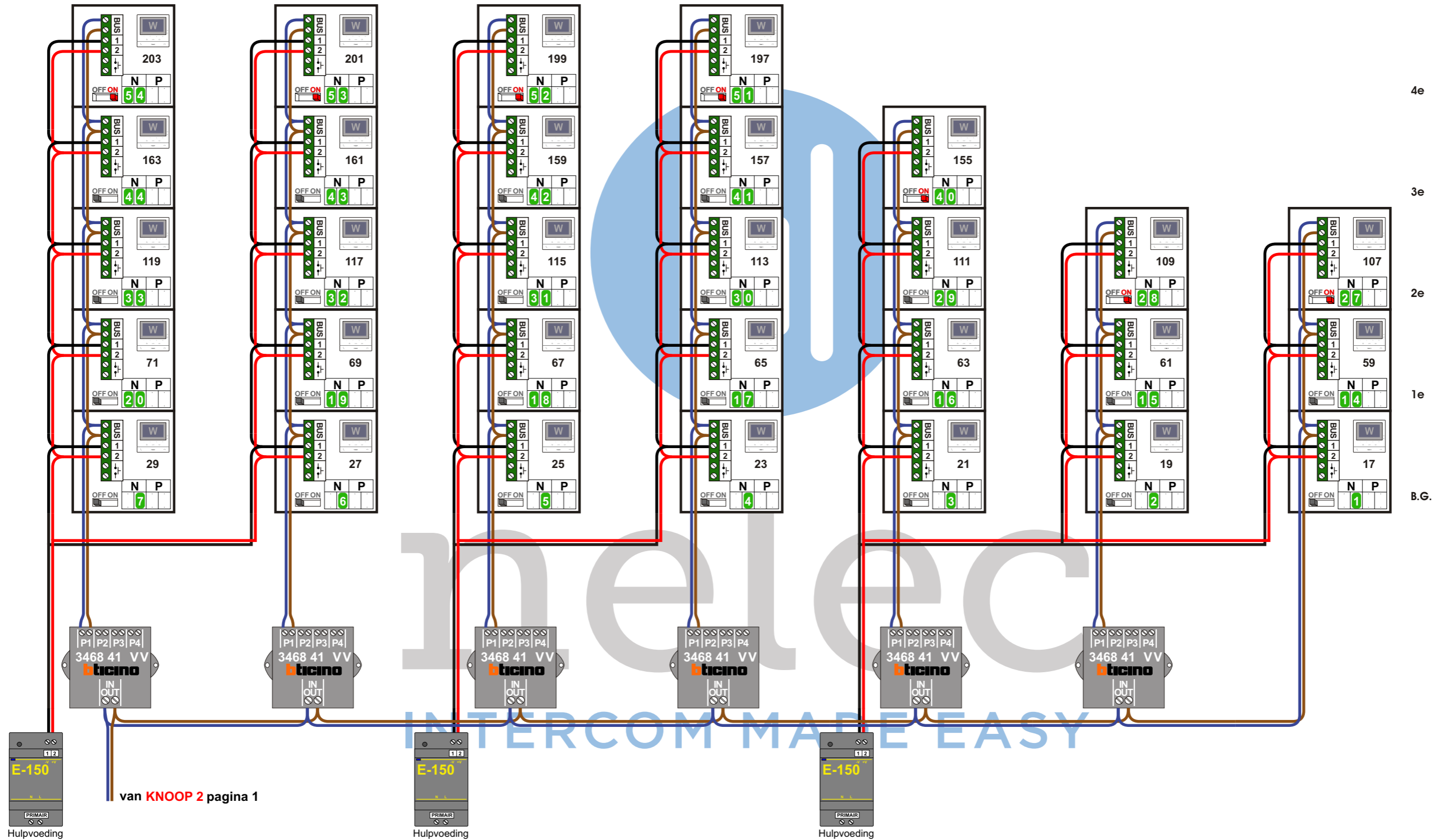
De aders moeten echt OP de connector doorgelust worden!



**TWEEDRAADS BUS**

 

Bij monteren/demonteren spanning eraf voorkomt defecten!

M-50e M-50W  
Bij hulpvoeding op 1-2: zet switch op ON

 2-1

**VideoVerdeler**



De aders moeten echt OP de klemmen doorgelust worden!

**M-50**



De aders moeten echt OP de connector doorgelust worden!

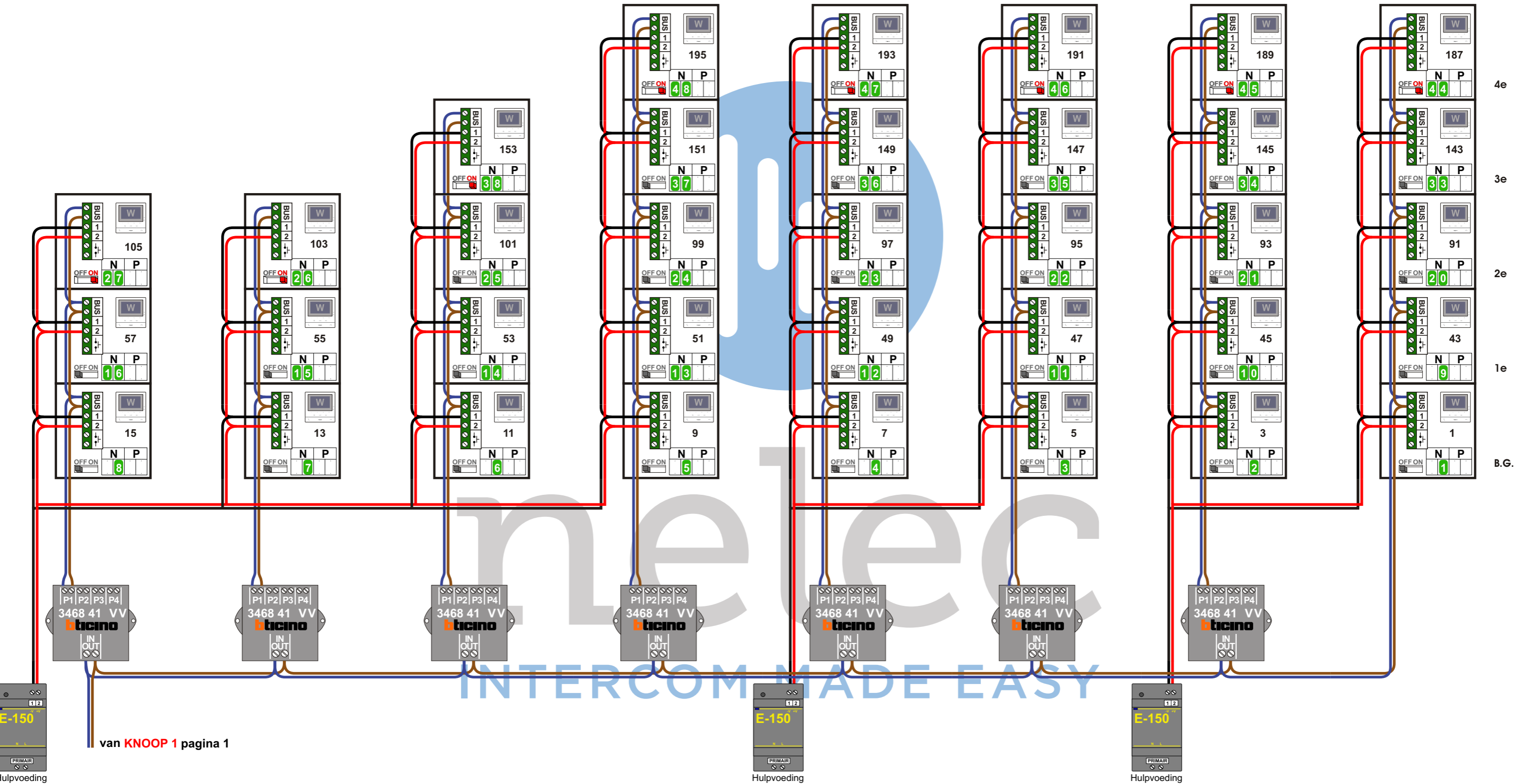

Vak 0 N=X+0

N-waarde	Huisnummer	Eindweerstand
1	1	
2	3	
3	5	
4	7	
5	9	
6	11	
7	13	
8	15	
9	43	
10	45	
11	47	
12	49	
13	51	
14	53	
15	55	
16	57	
17	85	
18	87	
19	89	
20	91	
21	93	
22	95	
23	97	
24	99	
25	101	
26	103	X
27	105	X
28	133	
29	135	
30	137	
31	139	
32	141	
33	143	
34	145	
35	147	
36	149	
37	151	
38	153	X
39	177	X
40	179	X
41	181	X
42	183	X
43	185	X
44	187	X
45	189	X
46	191	X
47	193	X
48	195	X

Vak 0 N=X+100

N-waarde	Huisnummer	Eindweerstand
1	17	
2	19	
3	21	
4	23	
5	25	
6	27	
7	29	
8	31	
9	33	
10	35	
11	37	
12	39	
13	41	
14	59	
15	61	
16	63	
17	65	
18	67	
19	69	
20	71	
21	73	
22	75	
23	77	
24	79	
25	81	
26	83	
27	107	X
28	109	X
29	111	
30	113	
31	115	
32	117	
33	119	
34	121	
35	123	
36	125	
37	127	
38	129	
39	131	
40	155	X
41	157	
42	159	
43	161	
44	163	
45	165	X
46	167	X
47	169	X
48	171	X
49	173	X
50	175	X
51	197	X
52	199	X
53	201	X
54	203	X



nelec  
INTERCOM MADE EASY