

— = systeemkabel
Bij andere getwiste kabel 66% afstand!
Bij ongetwiste kabel max. 50 meter buitenpost naar videofoon.
UTP op aanvraag.

Digitizers & flatcables

Niet monteren/demonteren onder spanning
Bedrukkers mogen wel

DD8 digitizer: flatcable

Connector van flatcable nokje juiste kant op bij aansluiten op DD8

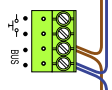
M-50

De aders moeten echt OP de connector doorgelust worden!

VideoVerdeler

De aders moeten echt OP de klemmen doorgelust worden!

M-50e M-50W
Bij hulpvoeding op 1-2: zet switch op ON



TWEEDRAADS BUS

Bij monteren/demonteren spanning eraf voorkomt defecten!

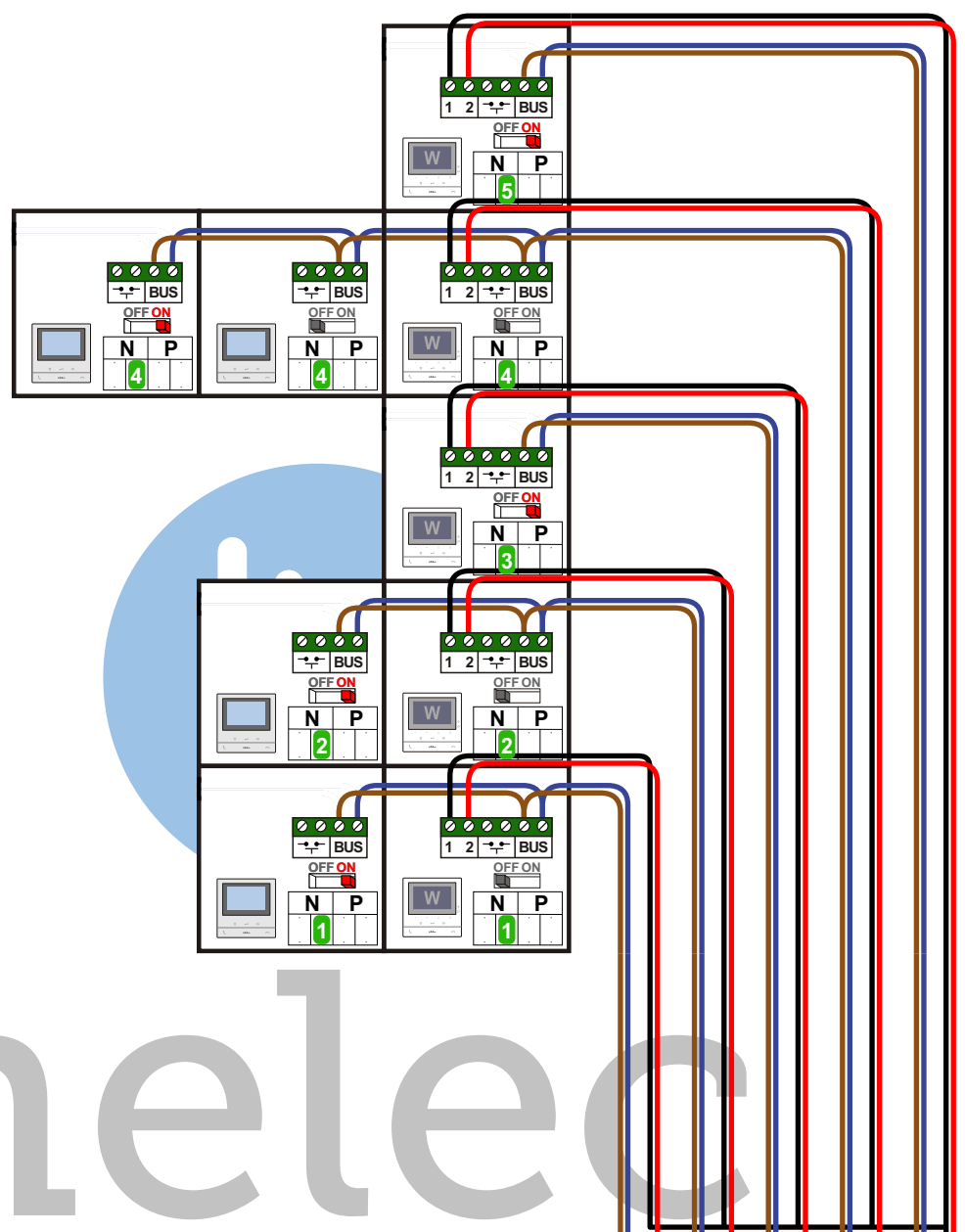
4E
4D
4C
4B
4A

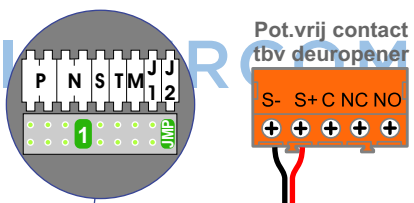

nelec
INTERCOM MADE EASY



Haal de spanning van het systeem als je de digitizer monteert of demonteert

DEURSTATION S-130V

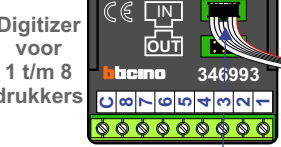
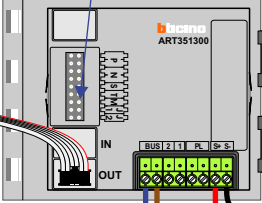

Digitizer voor 1 t/m 8 drukkers
nokjes connectoren wijzen naar elkaar

Max. 100 meter systeemkabel tot laatste videofoon

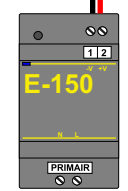
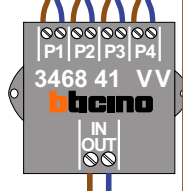
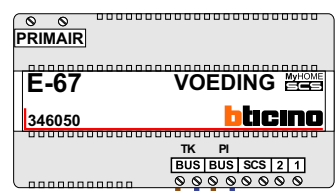

Hulpvoeding

Max. 50 meter

N-Waarde	Huisnummer	Videofoon	Switch-ON	1-2 ON
1	4A	M-50Wifi		X
1	4A	M-50B	X	
2	4B	M-50Wifi		X
2	4B	M-50B	X	
3	4C	M-50Wifi	X	X
4	4D	M-50Wifi		X
4	4D	M-50B		
4	4D	M-50B	X	
5	4E	M-50Wifi	X	X



nelec
INTERCOM MADE EASY