

— = systeemkabel
 Bij andere getwiste kabel 66% afstand!
 Bij ongetwiste kabel max. 50 meter buitenpost naar videofoon.
 UTP op aanvraag.

Digitizers & flatcables



Niet monteren/demonteren onder spanning
 Belrukkers mogen wel

TWEEDRAADS BUS



Bij monteren/demonteren spanning eraf voorkomt defecten!

M-50



De aders moeten echt OP de connector doorgelust worden!



De twee stijgers echt OP de klemmen van E-67 aansluiten!

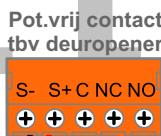
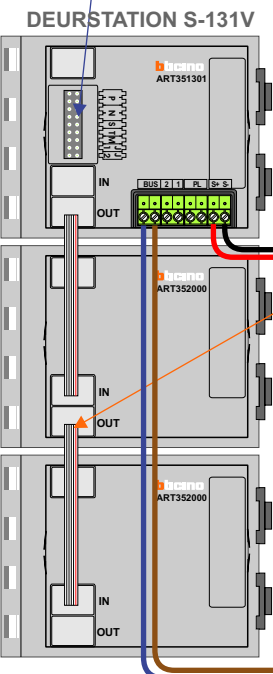
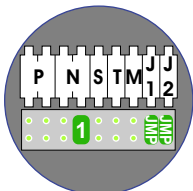
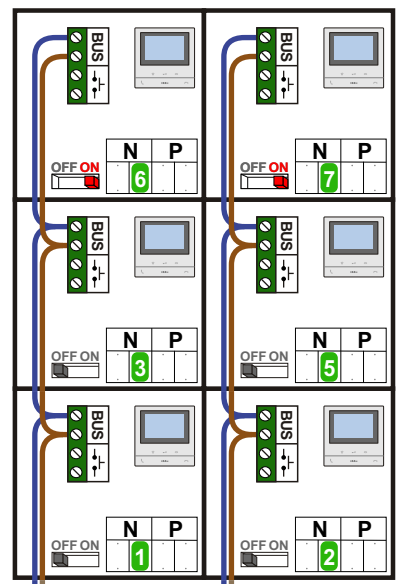

Haal de spanning van het systeem als je een module monteert of demonteert

Max. 100 meter systeemkabel tot laatste videofoon

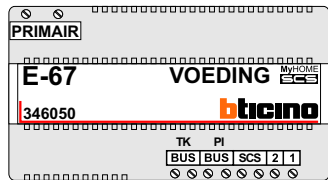

Max. 50 meter

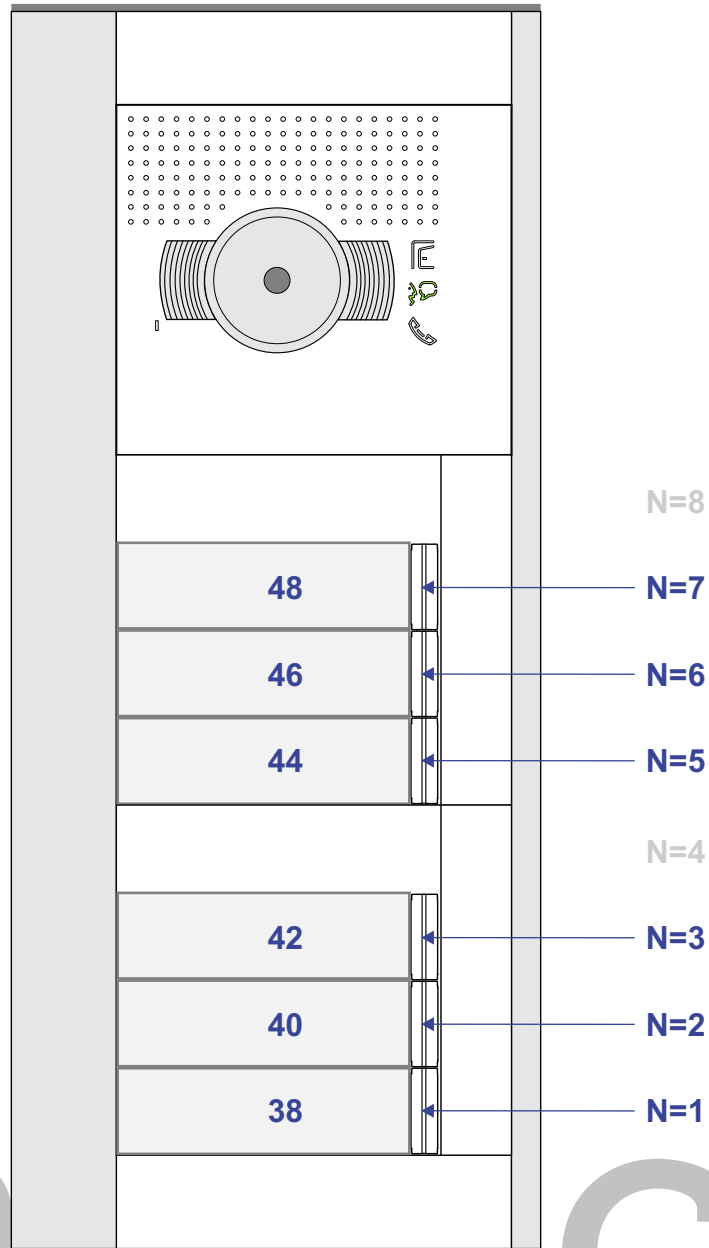

nelec

INTERCOM MADE EASY

N-Waarde	Huisnummer	Switch-ON
1	38	
2	40	
3	42	
5	44	
6	46	X
7	48	X