

— = systeemkabel
Bij andere getwiste kabel **66%** afstand!
Bij ongetwiste kabel **max. 50 meter** buitenpost naar videofoon.
UTP op aanvraag.

Digitizers & flatcables

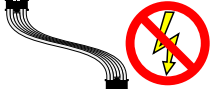

Niet monteren/demonteren onder spanning
Beldrukkers mogen wel

M-50

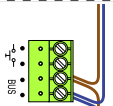

De aders moeten echt **OP** de connector doorgelust worden!

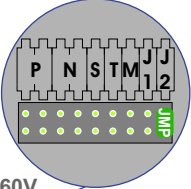

DEURSTATION S-160V

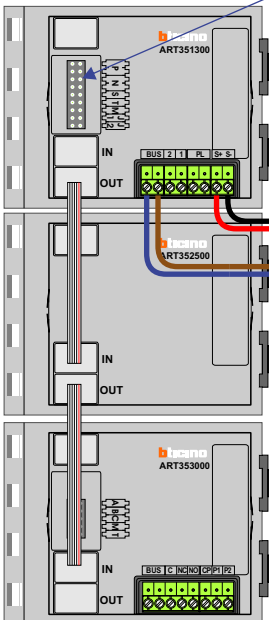

Pot.vrij contact tbv deur opener



TWEEDRAADS BUS



Bij monteren/demonteren spanning eraf voorkomt defecten!

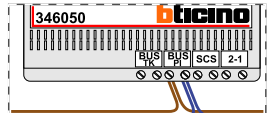

De twee stijgers echt **OP** de klemmen van E-67 aansluiten!

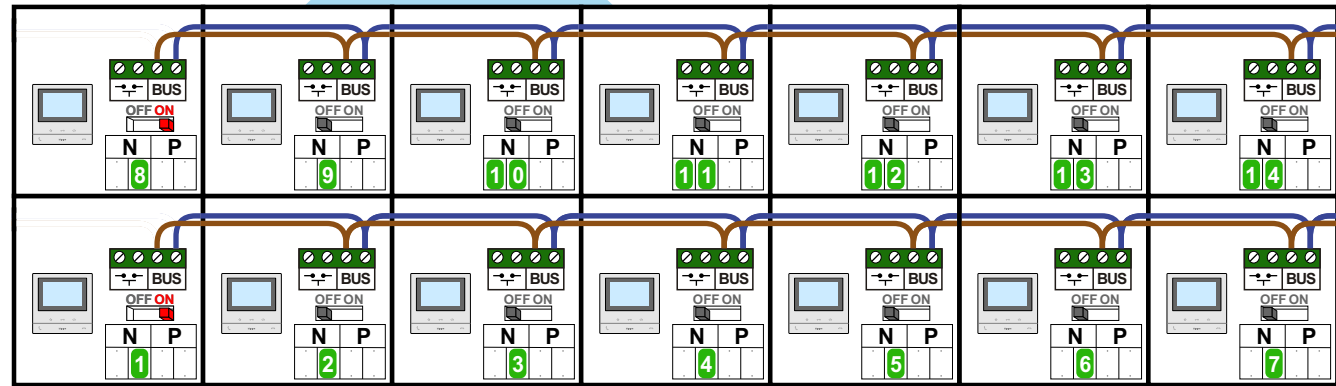

nelec
INTERCOM MADE EASY

Max. 100 meter systeemkabel tot laatste videofoon

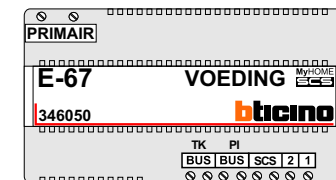

Max. 50 meter

N-Waarde	Huisnummer	Switch-ON
1	13	X
2	15	
3	17	
4	19	
5	21	
6	23	
7	25	
8	27	X
9	29	
10	31	
11	33	
12	35	
13	37	
14	39	

nelec
INTERCOM MADE EASY