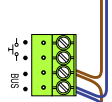
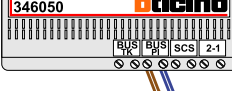

— = systeemkabel
Bij andere getwiste kabel 66% afstand!
Bij ongetwiste kabel max. 50 meter buitenpost naar videofoon.
UTP op aanvraag.

Digitizers & flatcables

Niet monteren/demonteren onder spanning
Bedrukkers mogen wel

M-50

De aders moeten echt OP de connector doorgelust worden!

346050 bticino

De twee stijgers echt OP de klemmen van E-67 aansluiten!

TWEEDRAADS BUS



Bij monteren/demonteren spanning eraf voorkomt defecten!



nelec

INTERCOM MADE EASY

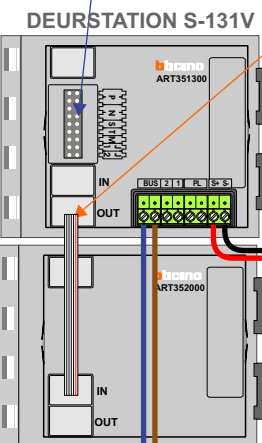
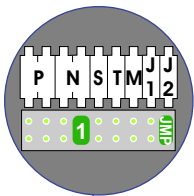
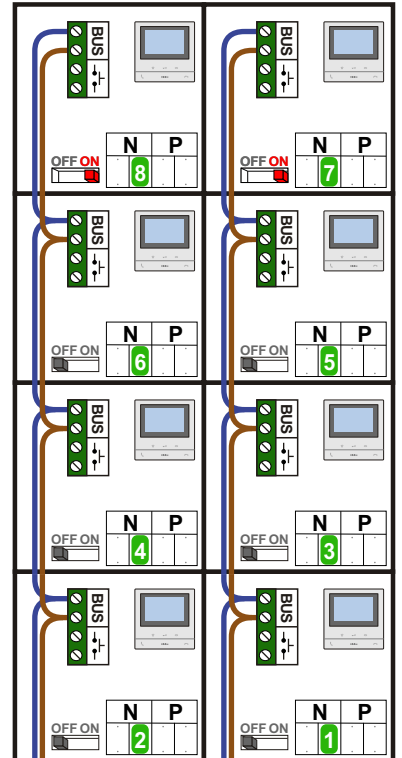

Haal de spanning van het systeem als je een module monteert of demonteert

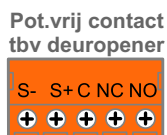

Max. 100 meter systeemkabel tot laatste videofoon

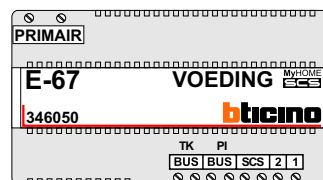

Max. 50 meter

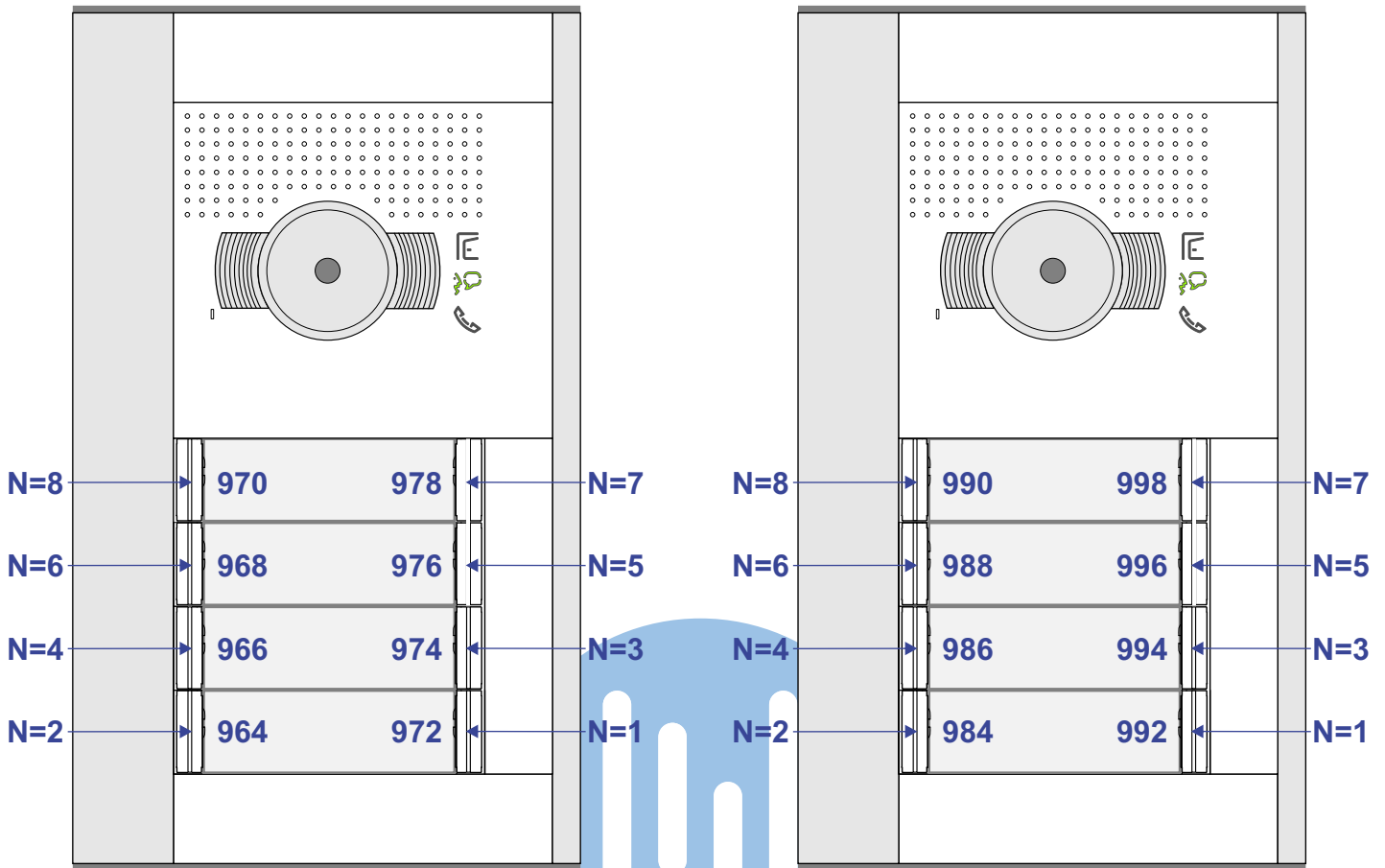

N-Waarde	Huisnummer	Switch-ON
1	972	
2	964	
3	974	
4	966	
5	976	
6	968	
7	978	X
8	970	X

N-Waarde	Huisnummer	Switch-ON
1	992	
2	984	
3	994	
4	986	
5	996	
6	988	
7	998	X
8	990	X

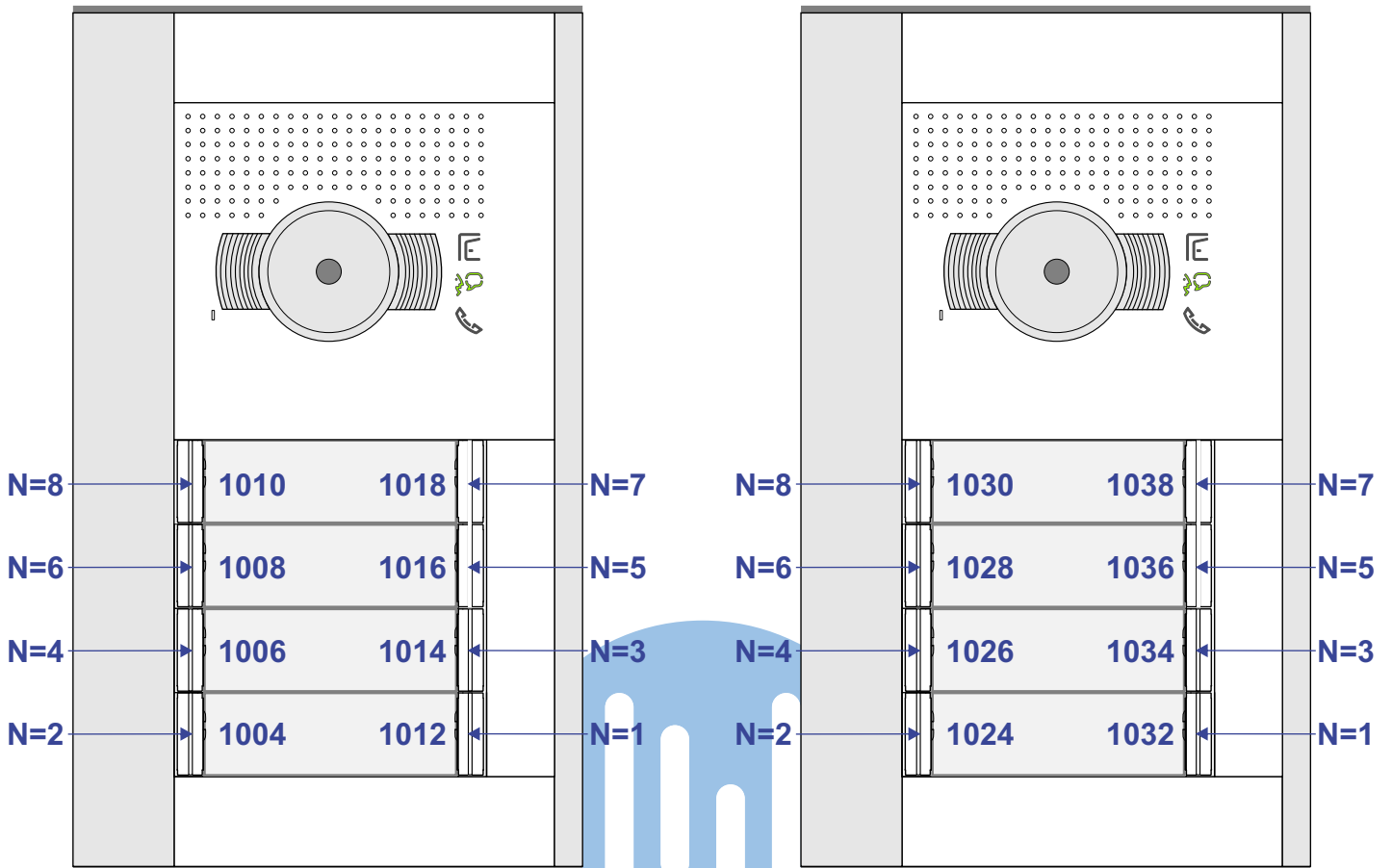

N-Waarde	Huisnummer	Switch-ON
1	1012	
2	1004	
3	1014	
4	1006	
5	1016	
6	1008	
7	1018	X
8	1010	X

N-Waarde	Huisnummer	Switch-ON
1	1032	
2	1024	
3	1034	
4	1026	
5	1036	
6	1028	
7	1038	X
8	1030	X

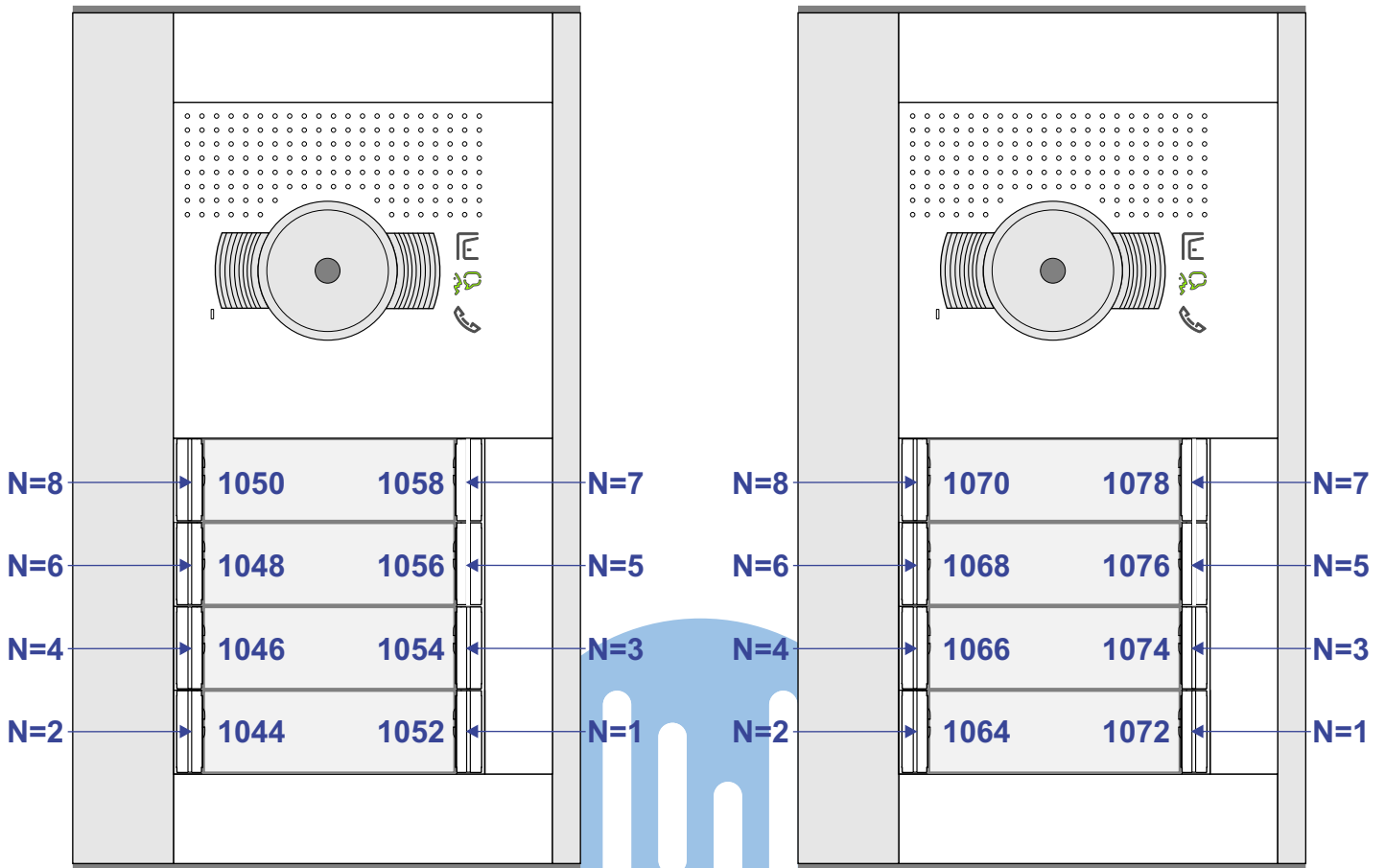

N-Waarde	Huisnummer	Switch-ON
1	1052	
2	1044	
3	1054	
4	1046	
5	1056	
6	1048	
7	1058	X
8	1050	X

N-Waarde	Huisnummer	Switch-ON
1	1072	
2	1064	
3	1074	
4	1066	
5	1076	
6	1068	
7	1078	X
8	1070	X