

— = systeemkabel
Bij kabel 2 x 1 mm²:
180% afstand!
Bij kabel 2 x 0,28 mm²:
60% afstand!
UTP op aanvraag.

TWEEDRAADS BUS



Bij monteren/demonteren
spanning eraf
voorkomt defecten!

Digitizers & flatcables

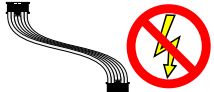

Niet monteren/demonteren
onder spanning
Beldrukkers mogen wel

DD8 digitizer: flatcable

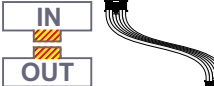

Connector van flatcable
nokje juiste kant op
bij aansluiten op DD8

M-50

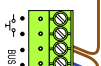

De aders moeten
echt **OP** de connector
doorgelust worden!

VideoVerdeler



De aders moeten
echt **OP** de klemmen
doorgelust worden!

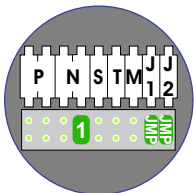
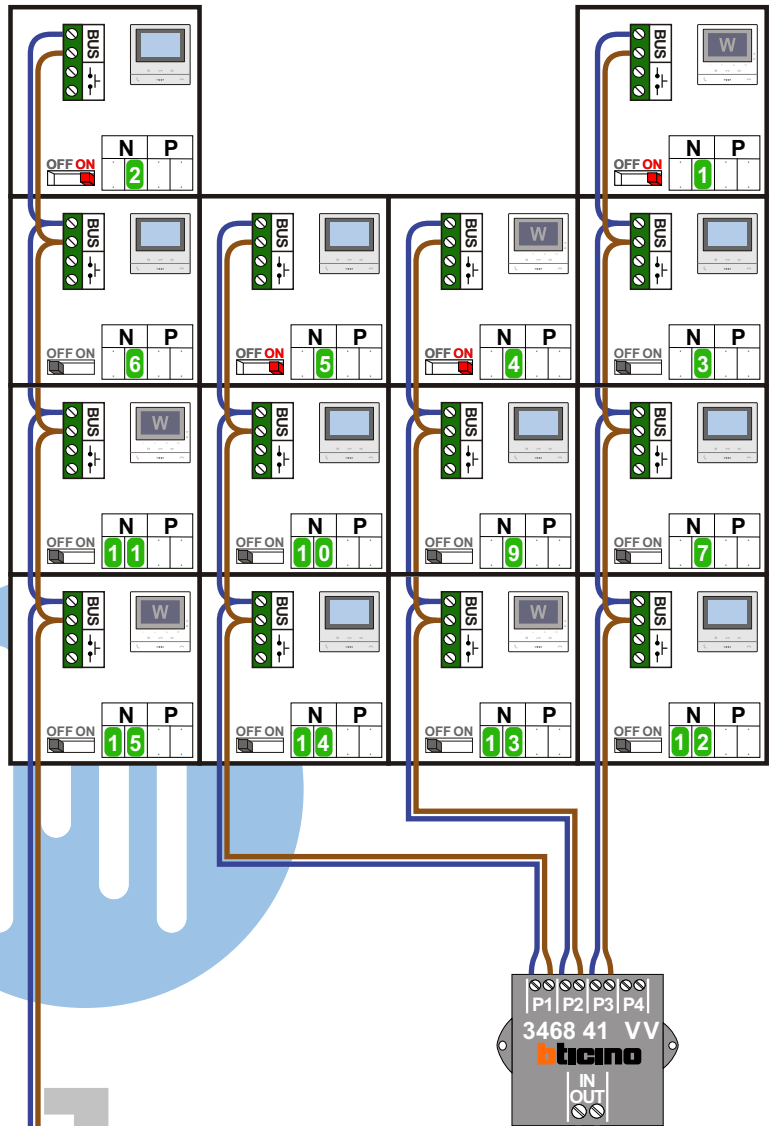

Haal de spanning van het
systeem als je een module
monteert of demonteert

DEURSTATION S-131V

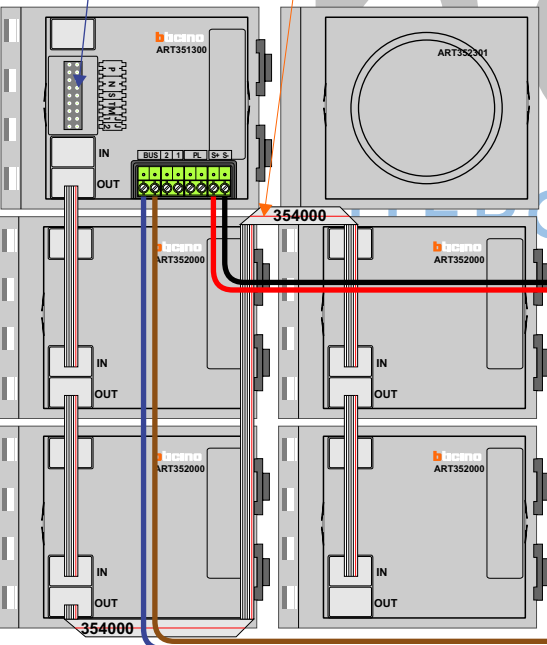

Pot.vrij contact
tbv deuropener



Max. 100 meter systeem-
kabel tot laatste videofoon

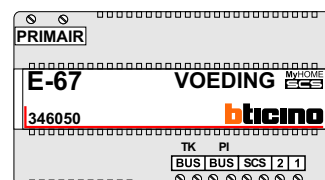

Max. 50 meter

N-Waarde	Huisnummer	Switch-ON	Videfoon
1	28	X	M-50W ifi
2	26	X	M-50B
3	24		M-50B
4	22	X	M-50W ifi
5	20	X	M-50B
6	18		M-50B
7	16		M-50B
8			
9	14		M-50B
10	12		M-50B
11	10		M-50W ifi
12	8		M-50B
13	6		M-50W ifi
14	4		M-50B
15	2		M-50W ifi
16			

